

CAPITOL RADIATORS



UNITED STATES RADIATOR CORPORATION

DETROIT, MICHIGAN

GUARANTEED

Every radiator made by the United States Radiator Corporation is positively guaranteed to be free from any imperfections in materials or workmanship, and to give entire satisfaction in the work for which it is intended.



*with
Standardized Ratings*

SEPTEMBER 1, 1928

Reprint, November, 1930

UNITED STATES RADIATOR CORPORATION

Detroit, Michigan

EIGHT MANUFACTURING PLANTS AND THIRTY-FIVE ASSEMBLING PLANTS SERVE THE COUNTRY

For 40 years, builders of dependable heating equipment

Copyright, 1928

CAPITOL THREE TUBE RADIATORS

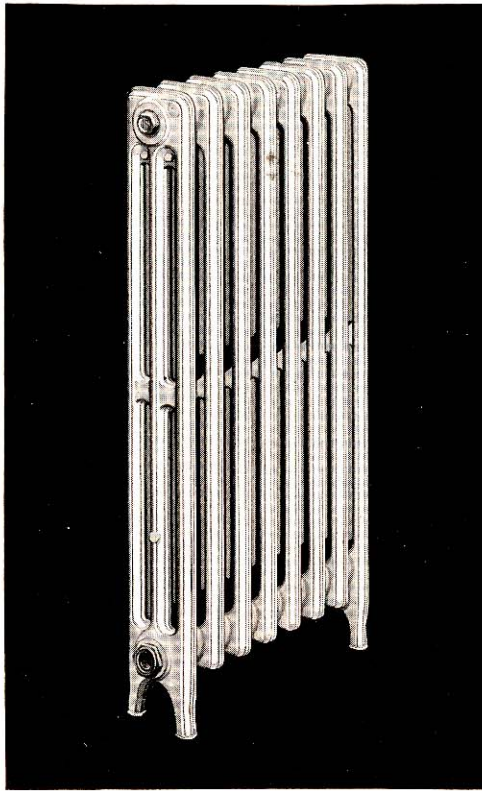

CAPITOL THREE TUBE

LONG research and study preceded each step in the design of the Capitol radiator. No enthusiasm was permitted to hurry out an immature radiator that might require changing later. Every detail was checked for strength, every line scrutinized for beauty. Extreme narrowness with unusual stability on its feet is the outstanding feature of the Capitol three tube radiator.



CAPITOL THREE TUBE RADIATORS

FOR STEAM OR WATER

No. of Sections	*Length Inches	HEATING SURFACE—SQUARE FEET				
		36-inch Height 3 1/2 Sq. Ft. Per Section	30-inch Height 3 Sq. Ft. Per Section	26-inch Height 2 1/2 Sq. Ft. Per Section	23-inch Height 2 Sq. Ft. Per Section	20-inch Height 1 3/4 Sq. Ft. Per Section
2	5	7	6	4 3/8	4	3 1/2
3	7 1/2	10 1/2	9	7	6	5 1/4
4	10	14	12	9 1/2	8	7
5	12 1/2	17 1/2	15	11 3/4	10	8 3/4
6	15	21	18	14	12	10 1/2
7	17 1/2	24 1/2	21	16 1/2	14	12 1/4
8	20	28	24	18 3/4	16	14
9	22 1/2	31 1/2	27	21	18	15 3/4
10	25	35	30	23 1/2	20	17 1/2
11	27 1/2	38 1/2	33	25 3/4	22	19 1/4
12	30	42	36	28	24	21
13	32 1/2	45 1/2	39	30 1/2	26	22 3/4
14	35	49	42	32 3/4	28	24 1/2
15	37 1/2	52 1/2	45	35	30	26 1/4
16	40	56	48	37 1/2	32	28
17	42 1/2	59 1/2	51	39 3/4	34	29 3/4
18	45	63	54	42	36	31 1/2
19	47 1/2	66 1/2	57	44 1/2	38	33 1/4
20	50	70	60	46 3/4	40	35
21	52 1/2	73 1/2	63	49	42	36 3/4
22	55	77	66	51 1/2	44	38 1/2
23	57 1/2	80 1/2	69	53 3/4	46	40 1/4
24	60	84	72	56	48	42
25	62 1/2	87 1/2	75	58 1/2	50	43 3/4

*Allow 1/2 inch for each bushing in estimating length of radiators. Tappings 1 1/2 inches, top and bottom, bushed as per list on page 16, unless otherwise specified. Furnished with 6 inch legs on special order, or without legs as illustrated on page 12. Special shapes shown on page 14.

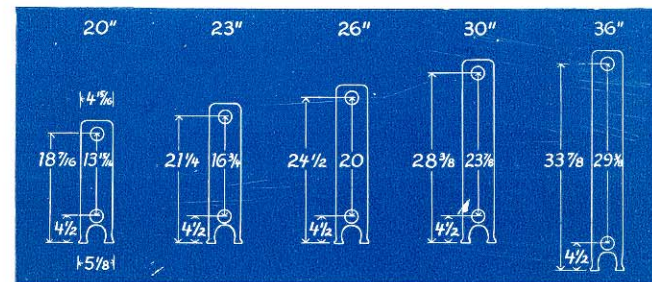

CAPITOL FOUR TUBE RADIATORS

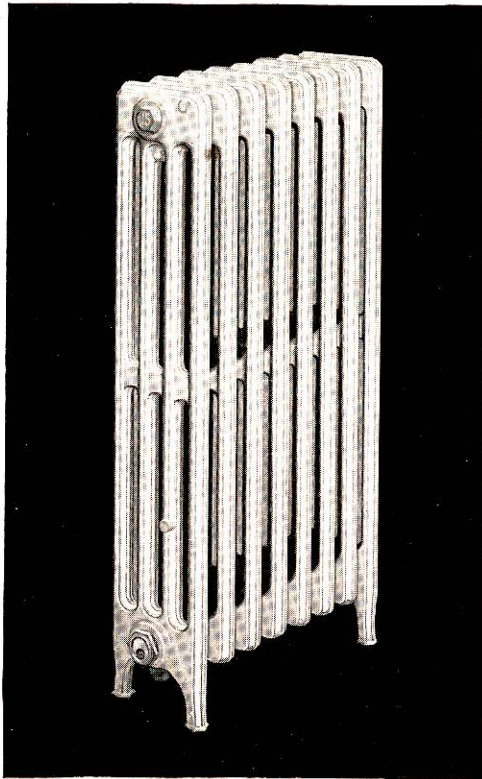

CAPITOL FOUR TUBE

DECORATORS with a feeling for lovely line, engineers who understand heating, both acclaim the new Capitol as the radiator masterpiece. Never has heating efficiency been clothed with greater symmetry. Capitol four tube radiators meet the demand for a maximum of footage where conditions of installation require narrow radiation in a limited wall space.



CAPITOL FOUR TUBE RADIATORS

FOR STEAM OR WATER

No. of Sections	*Length Inches	HEATING SURFACE—SQUARE FEET				
		37-inch Height	32-inch Height	26-inch Height	23-inch Height	20-inch Height
		4 1/4 Sq. Ft. Per Section	3 1/2 Sq. Ft. Per Section	2 3/4 Sq. Ft. Per Section	2 1/2 Sq. Ft. Per Section	2 1/4 Sq. Ft. Per Section
2	5	8 1/2	7	5 1/2	5	4 1/2
3	7 1/2	12 3/4	10 1/2	8 1/4	7 1/2	6 3/4
4	10	17	14	11	10	9
5	12 1/2	21 1/4	17 1/2	13 3/4	12 1/2	11 1/4
6	15	25 1/2	21	16 1/2	15	13 1/2
7	17 1/2	29 3/4	24 1/2	19 1/4	17 1/2	15 3/4
8	20	34	28	22	20	18
9	22 1/2	38 1/4	31 1/2	24 3/4	22 1/2	20 1/4
10	25	42 1/2	35	27 1/2	25	22 1/2
11	27 1/2	46 3/4	38 1/2	30 1/4	27 1/2	24 3/4
12	30	51	42	33	30	27
13	32 1/2	55 1/4	45 1/2	35 3/4	32 1/2	29 1/4
14	35	59 1/2	49	38 1/2	35	31 1/2
15	37 1/2	63 3/4	52 1/2	41 1/4	37 1/2	33 3/4
16	40	68	56	44	40	36
17	42 1/2	72 1/4	59 1/2	46 3/4	42 1/2	38 1/4
18	45	76 1/2	63	49 1/2	45	40 1/2
19	47 1/2	80 3/4	66 1/2	52 1/4	47 1/2	42 3/4
20	50	85	70	55	50	45
21	52 1/2	89 1/4	73 1/2	57 3/4	52 1/2	47 1/4
22	55	93 1/2	77	60 1/2	55	49 1/2
23	57 1/2	97 3/4	80 1/2	63 1/4	57 1/2	51 3/4
24	60	102	84	66	60	54
25	62 1/2	106 1/4	87 1/2	68 3/4	62 1/2	56 1/4

*Allow 1/2 inch for each bushing in estimating length of radiators. Tappings 1 1/2 inches, top and bottom, bushed as per list on page 16, unless otherwise specified. Furnished with 6 inch legs on special order, or without legs as illustrated on page 12. Special shapes shown on page 14.

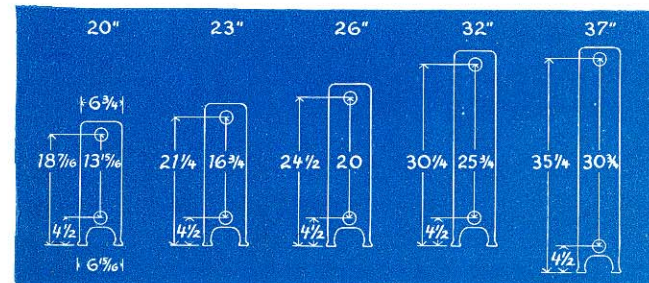

CAPITOL FIVE TUBE RADIATORS

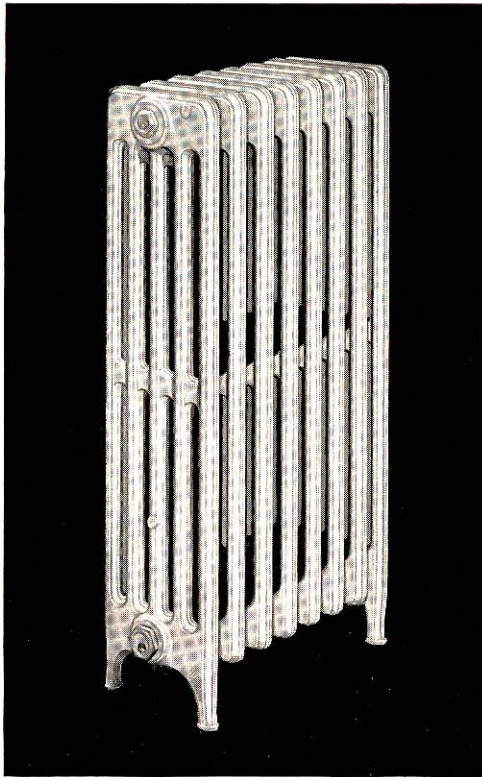

CAPITOL FIVE TUBE

IN our judgment, the Capitol is considered by far the finest and most efficient radiator that we have ever produced. The prime feature of the five tube is the unusual amount of surface per section. This extra surface is obtained without sacrificing efficiency by reducing air passages. Uniform ample air passages are maintained in all Capitol patterns.



CAPITOL FIVE TUBE RADIATORS

FOR STEAM OR WATER

No. of Sections	*Length Inches	HEATING SURFACE—SQUARE FEET				
		37-inch Height 5 Sq. Ft. Per Section	32-inch Height 4 1/2 Sq. Ft. Per Section	26-inch Height 3 1/2 Sq. Ft. Per Section	23-inch Height 3 Sq. Ft. Per Section	20-inch Height 2 1/2 Sq. Ft. Per Section
2	5	10	8 1/2	7	6	5 1/2
3	7 1/2	15	13	10 1/2	9	8
4	10	20	17 1/2	14	12	10 1/2
5	12 1/2	25	21 3/4	17 1/2	15	13 1/2
6	15	30	26	21	18	16
7	17 1/2	35	30 1/2	24 1/2	21	18 1/2
8	20	40	34 3/4	28	24	21 1/2
9	22 1/2	45	39	31 1/2	27	24
10	25	50	43 1/2	35	30	26 3/4
11	27 1/2	55	47 3/4	38 1/2	33	29 1/2
12	30	60	52	42	36	32
13	32 1/2	65	56 1/2	45 1/2	39	34 3/4
14	35	70	60 3/4	49	42	37 1/2
15	37 1/2	75	65	52 1/2	45	40
16	40	80	69 1/2	56	48	42 3/4
17	42 1/2	85	73 3/4	59 1/2	51	45 1/2
18	45	90	78	63	54	48
19	47 1/2	95	82 1/2	66 1/2	57	50 3/4
20	50	100	86 3/4	70	60	53 1/2
21	52 1/2	105	91	73 1/2	63	56
22	55	110	95 1/2	77	66	58 3/4
23	57 1/2	115	99 3/4	80 1/2	69	61 1/2
24	60	120	104	84	72	64
25	62 1/2	125	108 1/2	87 1/2	75	66 3/4

*Allow 1/2 inch for each bushing in estimating length of radiators. Tappings 1 1/2 inches, top and bottom, bushed as per list on page 16, unless otherwise specified. Furnished with 6 inch legs on special order, or without legs as illustrated on page 12. Special shapes shown on page 14.

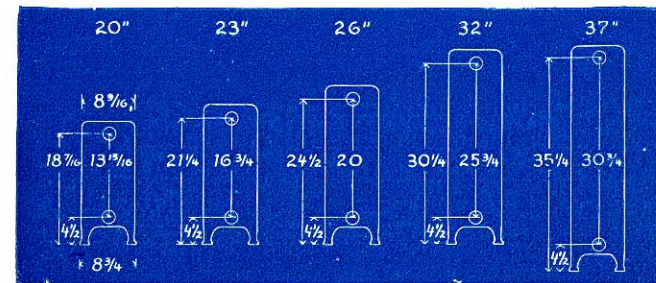

CAPITOL SIX TUBE RADIATORS

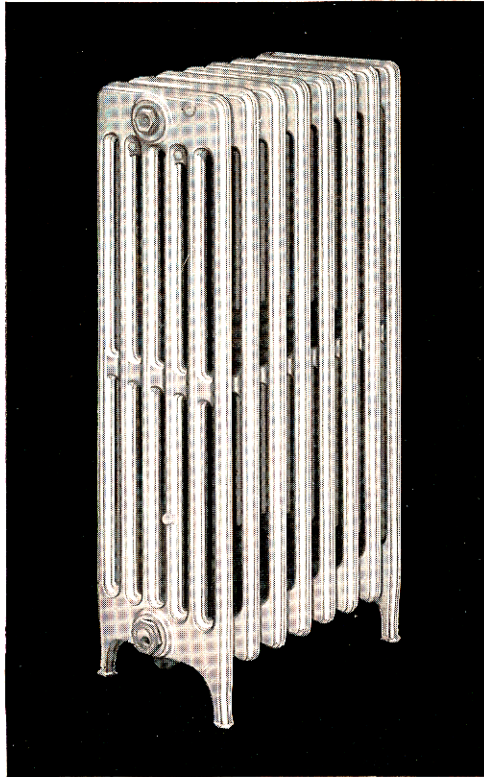

CAPITOL SIX TUBE

THESE attributes of the Capitol radiator: the clearly defined verticals, the play of lights and shadows on the delicate modeling, the lines of simple grace that somehow express a staunch strength beneath, all set a new standard of radiator beauty. This is maintained even in the six and seven tube patterns which meet the demand for mass radiation.



CAPITOL SIX TUBE RADIATORS

FOR STEAM OR WATER

No. of Sections	*Length Inches	HEATING SURFACE—SQUARE FEET				
		37-inch Height 6 Sq. Ft. Per Section	32-inch Height 5 Sq. Ft. Per Section	26-inch Height 4 Sq. Ft. Per Section	23-inch Height 3 1/2 Sq. Ft. Per Section	20-inch Height 3 Sq. Ft. Per Section
2	5	12	10	8	7	6
3	7 1/2	18	15	12	10 1/2	9
4	10	24	20	16	14	12
5	12 1/2	30	25	20	17 1/2	15
6	15	36	30	24	21	18
7	17 1/2	42	35	28	24 1/2	21
8	20	48	40	32	28	24
9	22 1/2	54	45	36	31 1/2	27
10	25	60	50	40	35	30
11	27 1/2	66	55	44	38 1/2	33
12	30	72	60	48	42	36
13	32 1/2	78	65	52	45 1/2	39
14	35	84	70	56	49	42
15	37 1/2	90	75	60	52 1/2	45
16	40	96	80	64	56	48
17	42 1/2	102	85	68	59 1/2	51
18	45	108	90	72	63	54
19	47 1/2	114	95	76	66 1/2	57
20	50	120	100	80	70	60
21	52 1/2	126	105	84	73 1/2	63
22	55	132	110	88	77	66
23	57 1/2	138	115	92	80 1/2	69
24	60	144	120	96	84	72
25	62 1/2	150	125	100	87 1/2	75

*Allow 1/2 inch for each bushing in estimating length of radiators. Tappings 1 1/2 inches, top and bottom, bushed as per list on page 16, unless otherwise specified. Furnished with 6 inch legs on special order, or without legs as illustrated on page 12. Special shapes shown on page 14.

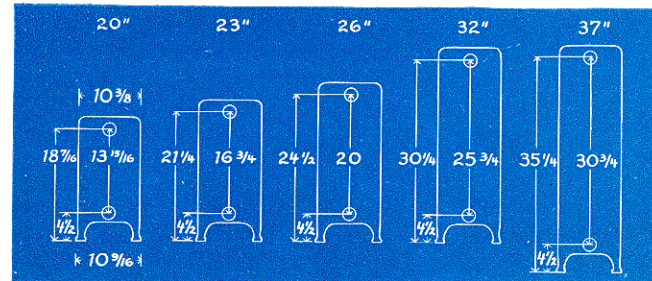

CAPITOL SEVEN TUBE WINDOW RADIATORS



CAPITOL SEVEN TUBE

NEITHER the slender tube effect nor the grace of the Capitol has been sacrificed in the seven tube model. There is hardly a window sill built too low for the thirteen inch height. The laboratory attests to the exceptionally high efficiency of low radiators and especially of the Capitol seven tube.

CAPITOL SEVEN TUBE WINDOW RADIATORS

FOR STEAM OR WATER

No. of Sections	*Length Inches	HEATING SURFACE—SQUARE FEET		
		20-inch Height 4 1/4 Sq. Ft. Per Section	16 1/2-inch Height 3 1/2 Sq. Ft. Per Section	13-inch Height 2 3/4 Sq. Ft. Per Section
2	5	8 1/2	7	5 1/2
3	7 1/2	12 3/4	10 1/2	8 1/4
4	10	17	14	11
5	12 1/2	21 1/4	17 1/2	13 3/4
6	15	25 1/2	21	16 1/2
7	17 1/2	29 3/4	24 1/2	19 1/4
8	20	34	28	22
9	22 1/2	38 1/4	31 1/2	24 3/4
10	25	42 1/2	35	27 1/2
11	27 1/2	46 3/4	38 1/2	30 1/4
12	30	51	42	33
13	32 1/2	55 1/2	45 1/2	35 3/4
14	35	59 1/2	49	38 1/2
15	37 1/2	63 3/4	52 1/2	41 1/4
16	40	68	56	44
17	42 1/2	72 1/4	59 1/2	46 3/4
18	45	76 1/2	63	49 1/2
19	47 1/2	80 3/4	66 1/2	52 1/4
20	50	85	70	55
21	52 1/2	89 1/4	73 1/2	57 3/4
22	55	93 1/2	77	60 1/2
23	57 1/2	97 3/4	80 1/2	63 1/4
24	60	102	84	66
25	62 1/2	106 1/4	87 1/2	68 3/4

*Allow 1/2 inch for each bushing in estimating length of radiators. Tappings 1 1/2 inches, top and bottom, bushed as per list on page 16, unless otherwise specified. Furnished with 4 1/2 inch legs on special order, or without legs as illustrated on page 12. Special shapes shown on page 14.

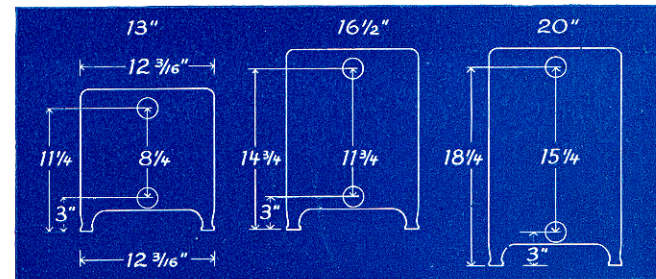

CAPITOL WALL RADIATORS

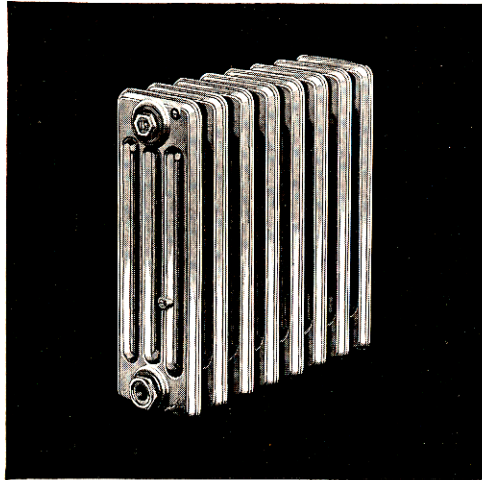

CAPITOL FOUR TUBE
WALL RADIATOR

THE growing demand for wall radiators is given added impetus by the vogue for fully carpeted floors. The housewife objects to cutting expensive carpeting for fitting it around piping. Besides the four tube illustrated, Capitol three, five, six, and seven tube radiators are supplied without legs. Dimensions, heights, tappings, etc., are the same as for the regular style.

CAPITOL HOSPITAL RADIATORS

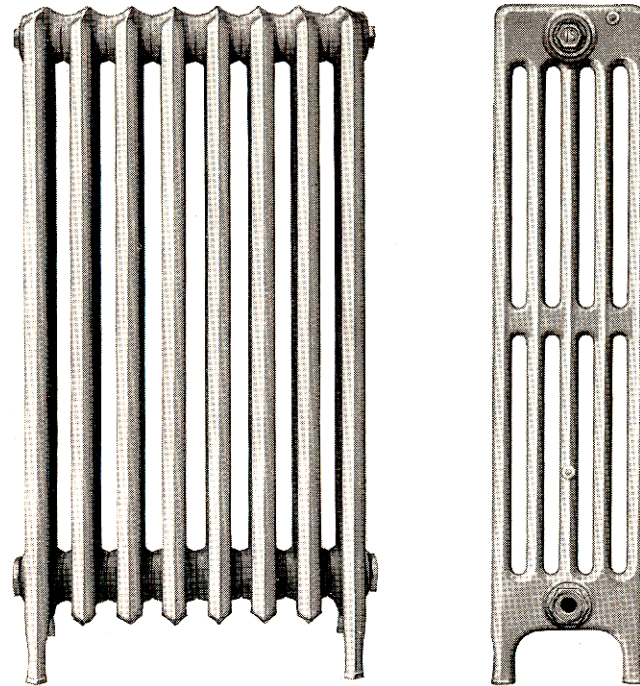

FOR STEAM OR WATER

EXTRA large spacing between sections allows the free access for thorough cleaning which is so essential in hospital radiators. Adaptable also for schools and other buildings where easy cleaning is essential.

Capitol Hospital Radiators are supplied in the three and five tube patterns only. Dimensions and heating surfaces are the same as for the regular styles listed on pages 3 and 7.

Capitol Hospital Radiators can be furnished on special order with 3" centers at no extra charge.

CAPITOL CORNER, CURVED, & PANTRY RADIATORS

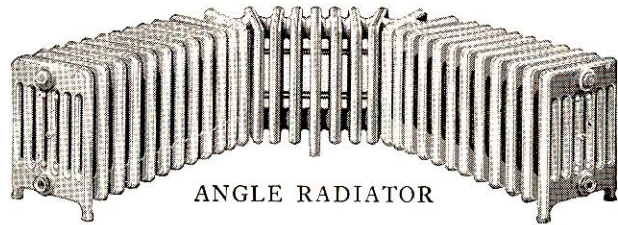

ANGLE RADIATOR

CORNER RADIATOR

Capitol special patterns include corner, curved, two and three angle radiators. Dimensions are the same as for Capitol regular styles. Capitol circular radiators can be furnished on special order, assembled either in one piece or in halves to be assembled on the job. Half circles may also be ordered for installation as two separate radiators.



PANTRY RADIATORS

A great aid in butler's pantries, restaurants and dining rooms. Heats rooms and affords the additional service of plate warming. Made up from seven-foot sections only and may be from one to five sections high. All openings on lower shelf are tapped.



Number	Height Inches	Nominal Surface Square Feet
1	7	7
2	17	15
3	27	23
4	37	31
5	47	39

Length 24 1/4 inches. Width 13 1/4 inches.
Above radiators are tapped 1 1/2 inches.

CAPITOL CURVED AND CORNER RADIATORS

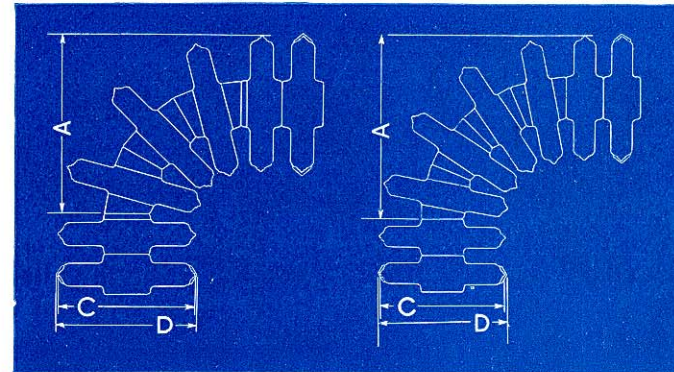

3 Section Corner Radiator Dimensions				4 Section Corner Radiator Dimensions			
Tube	A	C	D	Tube	A	C	D
3 Tube	8 ²⁹ / ₃₂	4 ¹⁵ / ₁₆	5 3/8	3 Tube	10 ⁹ / ₃₂	4 ¹⁵ / ₁₆	5 3/8
4 Tube	9 ¹³ / ₁₆	6 3/4	6 ¹⁵ / ₁₆	4 Tube	11 ³ / ₁₆	6 3/4	6 ¹⁵ / ₁₆
5 Tube	10 ²³ / ₃₂	8 ⁵ / ₁₆	8 7/8	5 Tube	12 ¹ / ₁₆	8 9/16	8 3/4
				6 Tube	14 ²⁷ / ₃₂	10 3/8	10 ⁹ / ₁₆
				7 Tube	15 ³ / ₄	12 ³ / ₁₆	12 ³ / ₁₆

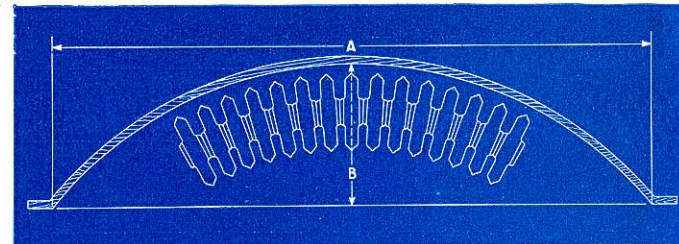

When ordering curved radiators, give measurements A and B

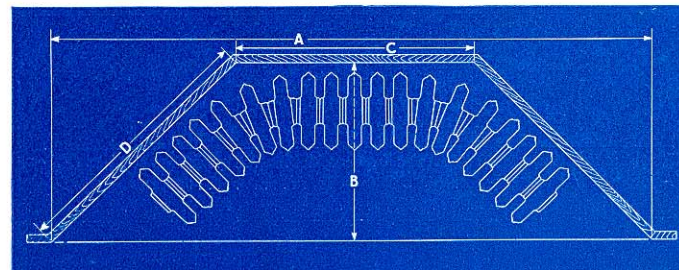

When ordering bay window radiators, give measurements A, B, C, and D

RADIATOR TAPPING LIST

ALL Capitol radiators are tapped one and one-half inches at top and bottom, both ends. Tappings are bushed as per list below, unless otherwise ordered.

All wall radiators are tapped one and one-half inches.

All Capitol Radiators have right-hand threads at both supply and return, and all Triton Wall Radiators have right-hand threads at one end, and left-hand threads at the other end.

All Air Valve tappings are $\frac{1}{8}$ inch. When radiators are ordered for special systems, such as vapor or vacuum, specific instructions should be given as to the method of tapping for supply, return, and vent.

STEAM
ONE-PIPE WORK

Radiators containing 24 square feet and under.....	1 inch
Above 24, but not exceeding 60 square feet.....	1 $\frac{1}{4}$ inch
Above 60 square feet.....	1 $\frac{1}{2}$ inch

TWO-PIPE WORK

Radiators containing 48 square feet and under.....	1 x $\frac{3}{4}$ inch
Above 48, but not exceeding 96 square feet.....	1 $\frac{1}{4}$ x 1 inch
Above 96 square feet.....	1 $\frac{1}{2}$ x 1 $\frac{1}{4}$ inch

WATER

Tapped for Supply and Return

Radiators containing 40 square feet and under.....	1 inch
Above 40, but not exceeding 72 square feet.....	1 $\frac{1}{4}$ inch
Above 72 square feet.....	1 $\frac{1}{2}$ inch

RADIATOR LEGS, FEET, AND PEDESTALS

CENTER LEGS

For all radiation: No center legs will be assembled in radiators up to and including 25 sections. Radiators from 26 to 49 sections inclusive have one center leg. Radiators from 50 to 73 sections inclusive have two center legs. Beyond 73 sections, three center legs will be used.

ADJUSTABLE FEET

Consist of two iron blocks that open by turning the top piece which is so cast that any radiator foot will fit securely. Adjustment can be made with the screw, which holds the two pieces in place. They can be used on any kind of fixture that must stand level. Furnished in plain iron and can be bronzed or painted to correspond to fixture upon them.

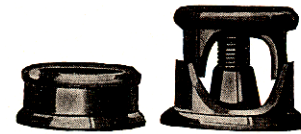

- No. 1 extends $\frac{7}{8}$ to 1 $\frac{1}{4}$ inches.
- No. 2 extends 1 $\frac{1}{4}$ to 1 $\frac{3}{4}$ inches.
- No. 3 extends 1 $\frac{1}{2}$ to 2 $\frac{1}{2}$ inches.
- No. 4 extends 2 to 3 inches.
- No. 5 extends 3 to 4 inches.
- No. 6 extends 4 to 5 inches.

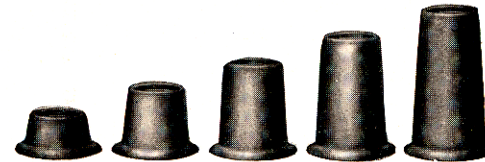

PEDESTALS

Solid cast-iron pedestals can be furnished for placing under legs of all styles of our radiators and are made in the following heights: $\frac{1}{2}$, $\frac{3}{4}$, 1, 1 $\frac{1}{2}$, 2, 2 $\frac{1}{2}$, 3, 3 $\frac{1}{2}$, 4, 4 $\frac{1}{2}$, 5, 5 $\frac{1}{2}$, and 6 inches.

CAPITOL DIRECT-INDIRECT BOX BASE

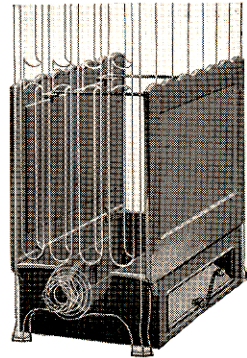

MADE for five tube Capitol radiators. When front damper is opened the back automatically closes, admitting air from the room only. When the back damper is opened the front closes, taking air from outdoors. Can be changed from back inlet to bottom inlet by setting both dampers to operate together. Front and back curtains can be removed for cleaning.

A 15-section Base is used on radiators of 15 sections or odd numbers above 15; and a 14-section Base is used on radiators of 14 sections or even numbers above 14.

When ordering Direct-Indirect radiators, specify sections under which the box base is to be installed, in order that center legs can be arranged accordingly.

CAPITOL DIRECT-INDIRECT BOX BASE



WALL BOXES

Water-tight and durable, with heavy copper screen firmly held in position at back of box, keeping out insects and dirt. The main part of the box is of one piece. From front flange to back of box, $2\frac{1}{2}$ inches; size of opening in brick work, $17\frac{1}{4} \times 5\frac{1}{8}$ inches; size for galvanized iron, $17 \times 4\frac{7}{8}$ inches. For application and data see below.

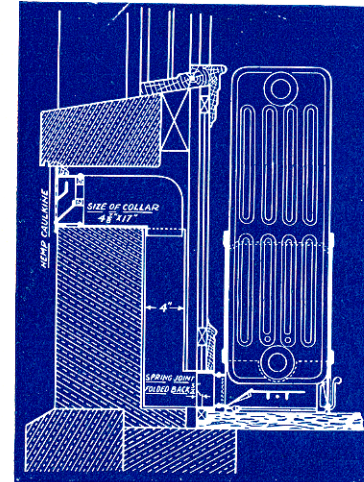

No. of Sec.	Back Opening 5 Tube	Maximum Bottom Opening 5 Tube	No. of Sec.	Back Opening 5 Tube	Maximum Bottom Opening 5 Tube
5	$2\frac{1}{16} \times 5\frac{3}{16}$	$8 \times 5\frac{1}{2}$	10	$2\frac{1}{16} \times 17\frac{1}{16}$	8×18
6	$2\frac{1}{16} \times 7\frac{11}{16}$	8×8	11	$2\frac{1}{16} \times 20\frac{5}{16}$	$8 \times 20\frac{1}{2}$
7	$2\frac{1}{16} \times 10\frac{3}{16}$	$8 \times 10\frac{1}{2}$	12	$2\frac{1}{16} \times 22\frac{1}{16}$	8×23
8	$2\frac{1}{16} \times 12\frac{11}{16}$	8×13	13	$2\frac{1}{16} \times 25\frac{3}{16}$	$8 \times 25\frac{1}{2}$
9	$2\frac{1}{16} \times 15\frac{5}{16}$	$8 \times 15\frac{1}{2}$	14	$2\frac{1}{16} \times 27\frac{1}{16}$	8×28
			15	$2\frac{1}{16} \times 30\frac{3}{16}$	$8 \times 30\frac{1}{2}$

Height of back air-inlet above floor $\frac{3}{8}$ inches.

PIN INDIRECT RADIATORS

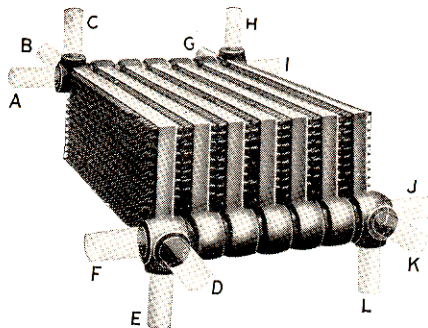

10 SQUARE FEET PER SECTION

Length of Section, Inches	Depth of Section, Inches	Depth Over All, Inches	Center to Center between Sections, Inches	Free Air Space between Sections, Sq. Ft.
36 1/4	7 3/4	8 5/8	3	.2703

Maximum tappings 1 1/2" at A, F, I, and J and 1 1/4" at B, C, D, E, G, H, K, and L.

15 SQUARE FEET PER SECTION

Length of Section, Inches	Depth of Section, Inches	Depth Over All, Inches	Center to Center between Sections, Inches	Free Air Space between Sections, Sq. Ft.
36 5/8	10 5/8	11 5/8	3	.2236

Maximum tappings 2" at A, F, I, and J and 1 1/2" at B, C, D, E, G, H, K, and L.

20 SQUARE FEET PER SECTION

Length of Section, Inches	Depth of Section, Inches	Depth Over All, Inches	Center to Center between Sections, Inches	Free Air Space between Sections, Sq. Ft.
36	14	14 3/4	3 1/2	.3494

Maximum tappings 2" at all openings.

Tappings on Indirect Radiators can be made at A, B, C, D, E, F, G, H, I, J, K, or L, but unless otherwise ordered they will be tapped at A and F, as follows:

Pin 10-ft. section, 1 1/2 in.; pin 15 and 20-ft. 2 in.; bushed as desired.

All pin Indirect sections are regularly connected with extra heavy malleable iron push nipples but on special order extra heavy right and left hand screw nipples having hexagon nut at center can be furnished.

Sections are assembled at factory and shipped complete, unless especially ordered otherwise. Thus the radiators can be thoroughly tested to prevent leaky joints and much of fitter's time in setting is saved.

When specially ordering sections shipped unassembled with bolts and nipples for putting together, always specify the number of stacks and number of sections in each stack, that the proper bolts may be sent.

See Engineering Data Catalogue for data on indirect radiators.

TRITON BATHROOM WALL RADIATOR

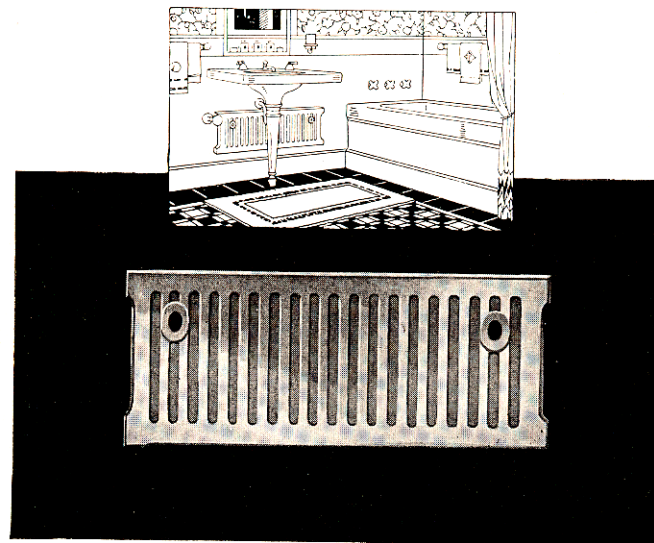

TRITON BATHROOM WALL RADIATOR

FITS under the lavatory, saving valuable space in modern bathrooms of limited dimensions. Attached with plain lag screws or hooks. Can be supplied in a new enamel finish, as immaculately white as the bathroom fixtures, that will neither chip, check, nor discolor.

Number	Height Inches	Length Inches	Thickness Inches	Nominal Surface Sq. Ft.	Center to Center Bolt Holes Inches
3A	8	16 1/2	1 1/2	3	11 1/2
3 1/2 A	8	20 1/2	1 1/2	3 1/2	15 1/2

Above radiators tapped 1/2 inch.

TRITON WALL RADIATORS

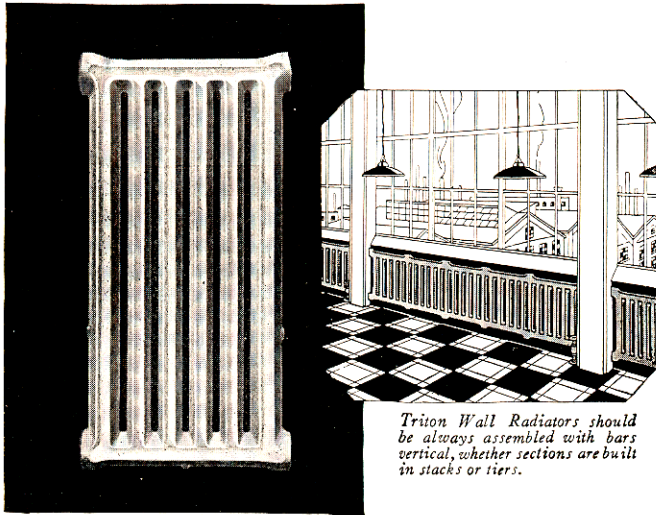

No. 9-B for side to side assembly

Triton Wall Radiators should be always assembled with bars vertical, whether sections are built in stacks or tiers.

FOR factories, storage houses, corridors, stairways, lobbies, and wherever the utmost radiating surface is needed in limited space, Triton Wall Radiators are unexcelled.

The wide variety of sizes adaptable to either tier or stack arrangement permits adapting their installation to any wall space available.

Sections may be added at any time should the building be enlarged. Steam or water may be confined to any number of the units during mild weather, assuring uniform temperatures with maximum economy. Condensed steam or exhaust steam often available in industrial installations may be utilized with the greatest efficiency.

No wall radiators are built that are more efficient, adaptable, or durable.

TRITON WALL RADIATORS

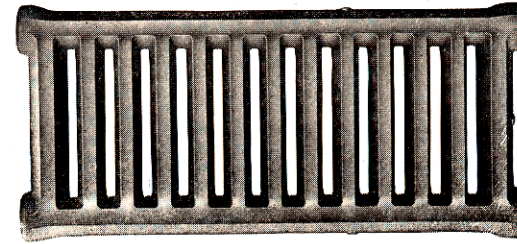

No. 9-A for end to end assembly

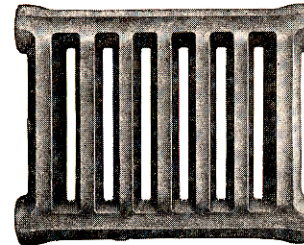

No. 5-A for end to end assembly

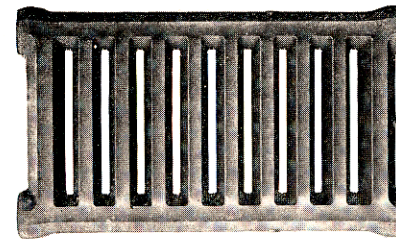

No. 7-A for end to end assembly



No. 7-B for side by side assembly

Section Numbers	Height Inches	Length or Width Inches	Thickness Inches	Thickness With Brkts. Inches	Heating Surface Sq. Ft.
5A	14 1/8	16 1/2	3	3 1/2	5
7A	14 1/8	22 3/8	3	3 1/2	7
9A	14 1/8	29 1/4	3	3 1/2	9
7B	22 7/8	14 1/8	3	3 1/2	7
9B	29 1/4	14 1/8	3	3 1/2	9

Above radiators are tapped 1 1/2 inches

TRITON WALL RADIATORS

IN ordering, state the size and number of sections to each radiator, give the assembly figure number and state the number of "Tiers" high or "Stacks" wide, as the case may be. State also the size and location of tappings desired, using the tapping numbers shown on figure for this purpose.

Sections are assembled for shipment only in single tiers or single stacks. Where figures show double tiers or double stacks it is to be understood that the figures will be shipped disconnected at the hexagon nipples. Note that when sections, regardless of type, are assembled side to side, the maximum number of sections which will be shipped assembled is, for each size:—

5 ft.—5 sections 9 ft.—5 sections
7 ft.—5 sections See Figures 9-11-13-15-2-6

And when assembled end to end the maximum number of sections which will be shipped assembled is, for each size:—

5 ft.—5 sections 9 ft.—3 sections
7 ft.—4 sections See Figures 1-3-5-7-15-8-10-12

The regular tappings as shown on the various assembly figures are indicated by 2, 3, 4, 5, 6, 7, 8 and 9. 12, 13, 14, 15, 16, 17, 18, 19 indicate special tappings which can be furnished at points so marked if required and for which an extra charge of 10 cents each, net, will be made.

Numbers 2, 9, 3, 4, and 12, 19, 13, 14 are left hand tappings.

Numbers 5, 6, 7, 8, and 15, 16, 17, 18 are right hand tappings.

Tappings are 1½" supply and return and are bushed as per list on page 16.

CRATING

Units of Triton Wall Radiators are crated as follows:

9 FOOT HORIZONTAL

When assembled as per Figure No. 1—3 sections and over
When assembled as per Figure No. 9—5 sections and over

7 FOOT HORIZONTAL

When assembled as per Figure No. 1—4 sections and over
When assembled as per Figure No. 9—5 sections and over

7 FOOT VERTICAL

When assembled as per Figure No. 2—5 sections and over
When assembled as per Figure No. 8—4 sections and over

9 FOOT VERTICAL

When assembled as per Figure No. 2—5 sections and over
When assembled as per Figure No. 8—3 sections and over

5 FOOT VERTICAL

All assembly of 5 sections and over

TRITON WALL RADIATORS

TABLE SHOWING LENGTH AND HEATING SURFACE OF TRITON WALL RADIATORS

No. of Sections	*LENGTH OF SECTIONS ONLY			HEATING SURFACE SQ. FT.		
	Type 5-A Ft. In.	Type 7-A Ft. In.	Type 9-A Ft. In.	Type 7-B and 9-B Ft. In.	Type 5-A Type 7-B	Type 9-A and Type 9-B
1	4½	1-10¾	2-5¼	1-2¾	5	9
2	9	3-9¾	4-10¾	2-4¼	10	18
3	4-1½	5-8¾	7-3¾	3-6¾	15	27
4	6	7-7½	9	4-8½	20	36
5	6-10½	9-6¾	12-2¼	5-10¾	25	45
6	8-3	11-5¼	14-7½	7-2¾	30	54
7	9-7½	13-4¾	17-¾	8-2¾	35	63
8	11-0	15-3	19-6	9-5	40	72
9	12-4½	17-1¾	21-11¼	10-7¾	45	81
10	13-9	19-¾	24-4¾	11-9¼	50	90
11	15-1½	20-11¾	26-9¾	12-11¾	55	99
12	16-6	22-10½	29-3	14-1½	60	108
13	17-10½	24-9¾	31-8¼	15-3¾	65	117
14	19-3	26-8¼	34-1½	16-5¾	70	126
15	20-7½	28-7½	36-6¾	17-7¾	75	135
16	22-0	30-6	39-0	18-10	80	144
17	23-4½	32-4¾	41-5¼	20-¾	85	153
18	24-9	34-3¾	43-10¾	21-2¼	90	162
19	26-1½	36-2¾	46-3¾	22-4¾	95	171
20	27-6	38-1½	48-9	23-6¾	100	180
21	28-10½	40-¾	51-2¼	24-8¾	105	189
22	30-3	41-11¾	53-7¾	25-10¾	110	198
23	31-7½	43-10¾	56-¾	27-¾	115	207
24	33-0	45-9	58-6	28-3	120	216
25	34-4½	47-7¾	60-11¼	29-5¾	125	225
26	35-9	49-6¾	63-4¾	30-7¾	130	234

*Add 1½" for each Bushing. Add 1¼" for each Hexagon Nipple. For Number of Hexagon Nipples and location in each assembly, see Chart Page 33.

See Triton "Wall Radiators" Page 24.

WALL RADIATOR ASSEMBLY

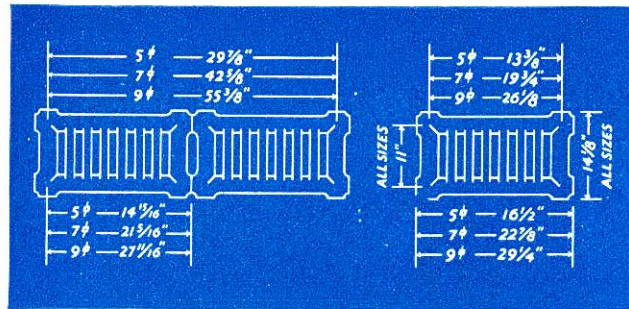

Above measurements apply to A or B styles.

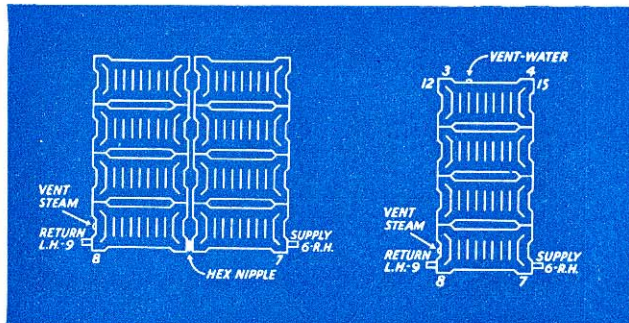

Fig. 13. Assembled in two or more stacks. One and two pipe steam only. Bottom feed.

Fig. 9. Assembled in single stack. Water or one and two pipe steam.

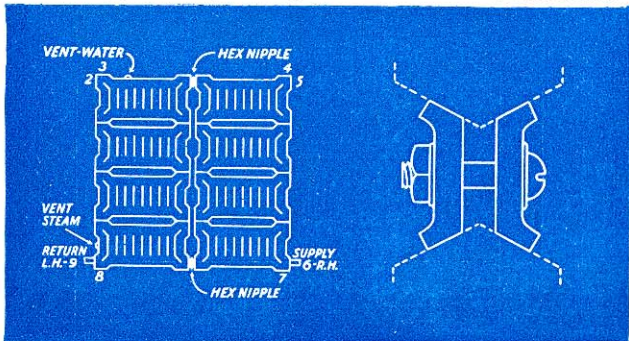

Fig. 11. Assembled in two or more stacks. Water or steam.

Adjustable Spacing Saddle. Furnished between sections. See figures 17, 16, and 18 on pages 27 and 29.

WALL RADIATOR ASSEMBLY

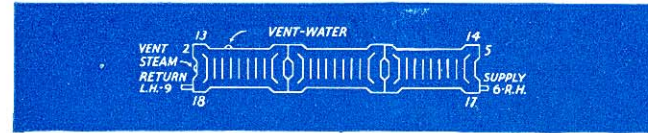

Fig. 1. Assembled in single tier. Water or one and two pipe steam.

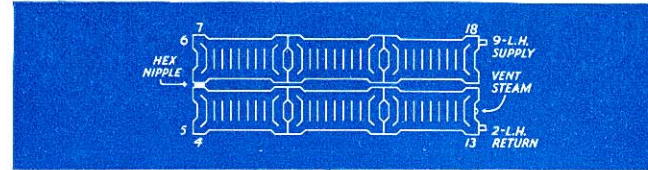

Fig. 7. Assembled in two tiers. Two pipe steam only.

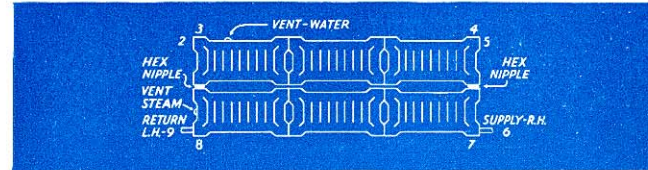

Fig. 3. Assembled in two or more tiers. Water or steam.

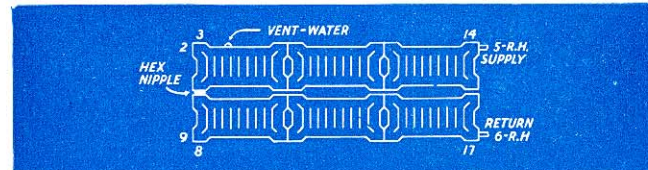

Fig. 5. Assembled in two tiers. Water only.

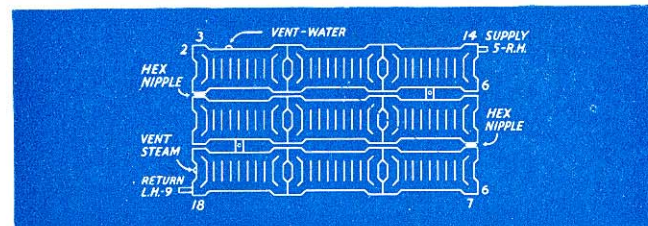
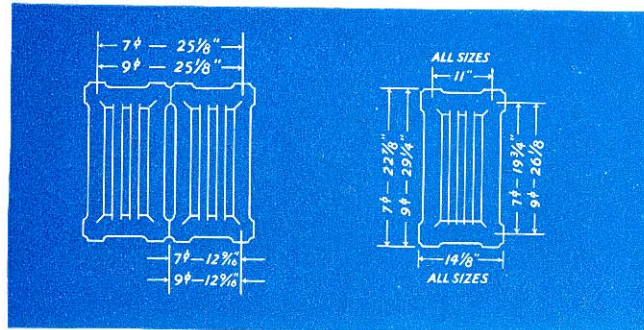

Fig. 17. Assembled nine sections in three tiers. Using adjustable spacing saddle.

WALL RADIATOR ASSEMBLY



Above measurements apply to A or B styles.

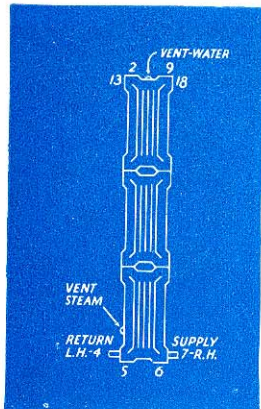

Fig. 8. Assembled in single stack. Water or one and two pipe steam.

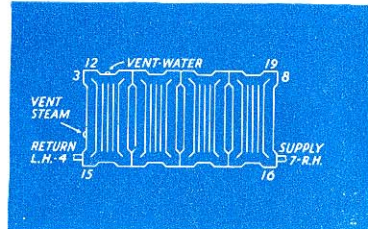

Fig. 2. Assembled in single tier. For water or one and two pipe steam.

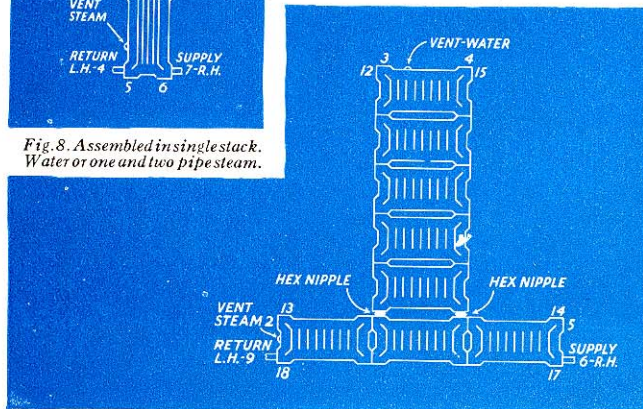

Fig. 15. Assembled in single tier and single stack. Water or one or two pipe steam.

WALL RADIATOR ASSEMBLY

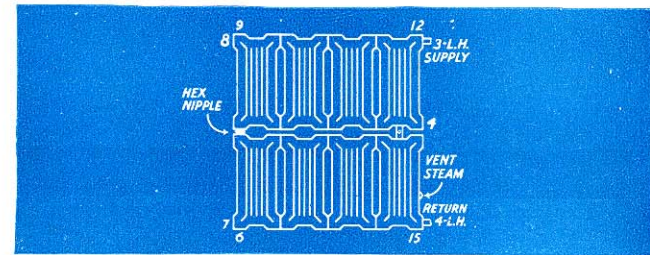

Fig. 16. Assembled in eight sections in two tiers. For two pipe steam using adjustable spacing saddle.

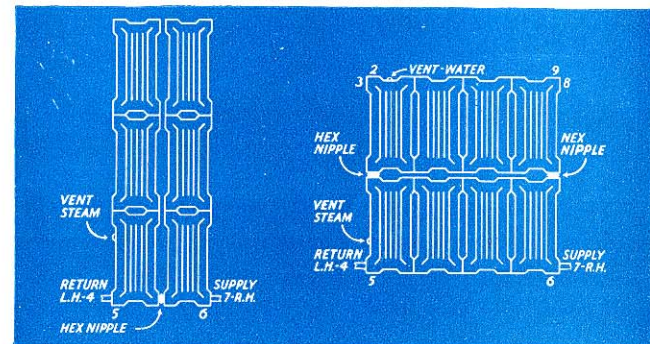

Fig. 12. Assembled in two or more stacks. One and two pipe steam only. Bottom feed. Fig. 6. Assembled in two or more tiers. Water or steam.

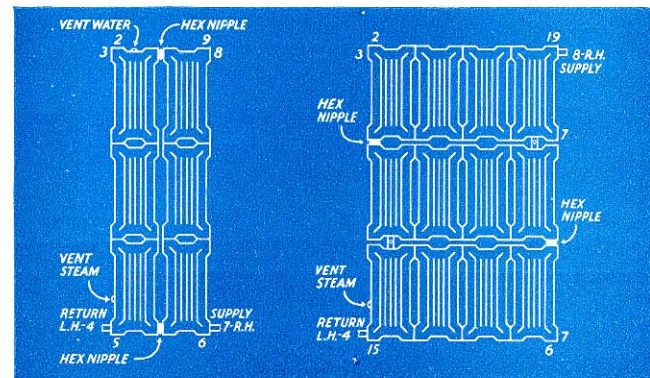
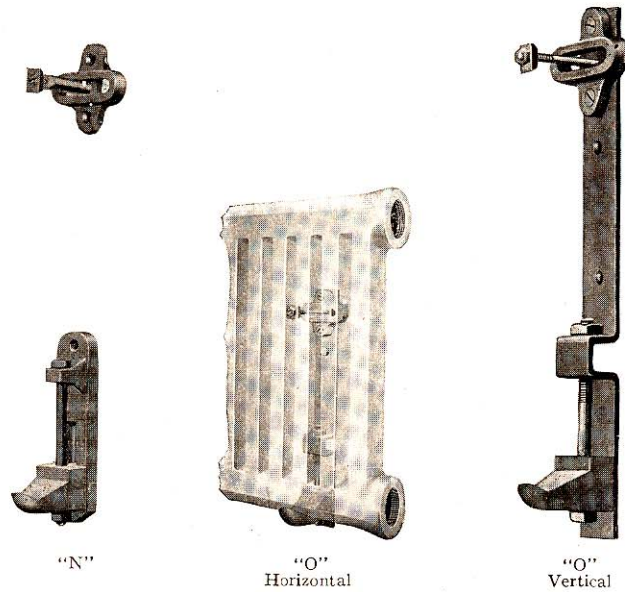

Fig. 10. Assembled in two or more stacks. Water or steam. Fig. 18. Assembled in twelve sections in three tiers. Using adjustable spacing saddle.

TRITON ADJUSTABLE WALL BRACKETS



ADJUSTABLE FOR PITCH AFTER RADIATOR IS ERECTED

Triton Adjustable Brackets are made to support wall radiators in large or small tiers or stacks in buildings of any character where wall radiation is installed.

They are strong and substantial, and hold radiators securely in place. They are adjusted after attachment to walls by a single expansion bolt.

Triton Adjustable Brackets are made in two styles.

"N" Brackets can be screwed to the wall to support any arrangement of wall radiation.

"O" Bracket, with bearing plate, is attached to wall with 1/2" Expansion Bolts, materially reducing the cost of construction and guaranteeing a safe and secure attachment.

Vertical movement of the seat of "N" and "O" Bracket is 2", permitting adjustment for pitch after radiators are erected. The brackets set the outer face of the radiator 4 3/8" from the wall.

Screw sizes suitable for use on "N" Bracket:

- Top Bracket—Size of hole, 1/4"—Use No. 14 Wood Screw.
- Bottom Bracket—Size of hole, 9/16"—Use 1/2" Lag Screw.
- "N" Brackets mounted on steel plates.
- Top Bracket, 3/8"—Flat Head Machine Screw to fasten to plate.
- Bottom Hole, 9/16"—For 1/2" Lag Screw to wall.
- Bottom Bracket, 3/8"—Machine Screw to fasten to plate.
- Bottom Hole—For 1/2" Lag Screw to fasten to wall.

For additional measurements and chart showing number and location of brackets on assemblages, see pages 32-33.

WALL RADIATOR BRACKETS

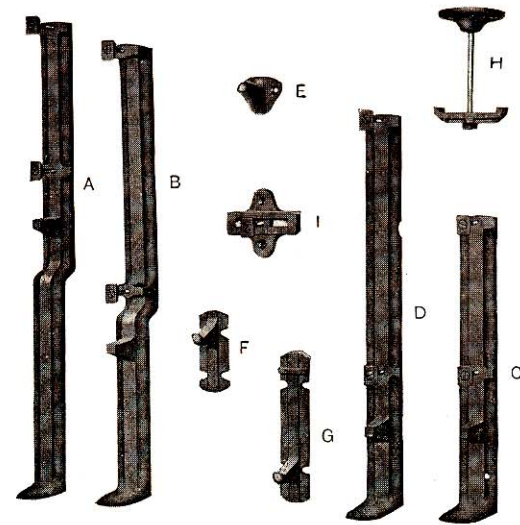

Brackets "B" to fit over a 9 1/2-inch high baseboard for supporting wall radiators Nos. 7-B and 9-B.

HEIGHT FROM FLOOR TO CENTER OF TAPPING

No. B 5 1/2 from floor to center.....	5 1/2"
No. B 7 1/2 from floor to center.....	7 1/2"
No. B 9 1/2 from floor to center.....	9 1/2"

Brackets "D" are straight right angle brackets without offset for supporting Nos. 7-B and 9-B. Distance from floor to center of tapping, 5 1/2 inches. Brackets "A" to fit over baseboard for supporting Nos. 5A, 7A and 9A.

HEIGHT FROM FLOOR TO CENTER OF TAPPING

No. A 6 will fit over baseboard.....	1 1/2"	6"
No. A 8 will fit over baseboard.....	3 1/2"	8"
No. A 10 will fit over baseboard.....	5 1/2"	10"
No. A 12 will fit over baseboard.....	7 1/2"	12"
No. A 14 will fit over baseboard.....	9 1/2"	14"
No. A 16 will fit over baseboard.....	11 1/2"	16"

Brackets "C" are straight right angle brackets without offset, for supporting Nos. 5A, 7A and 9A. Distance from floor to center of tapping, 5 1/2 inches.

Brackets "F," "G," "E," and "I" are screwed to wall, baseboard and wainscoting. "F" and "G" are bottom supports for all sizes; "E" and "I" top guides to hold radiator in place should always be used with "F" and "G" brackets. "F" and "G" brackets are slotted for four wood screws not furnished by us, and "E" and "I" are for two wood screws.

Ceiling brackets "H" for supporting radiator from ceilings, made of cast plate 3 3/8 inches in diameter to be screwed to ceiling joist by four screws. Bolt furnished gives a distance of from 3 1/2 to 5 inches from bottom of radiator to ceiling. Other lengths on special order.

With brackets "A," "B," "D," and "C" we furnish two 1/4 x 2 1/4 F. H. stove bolts with button, and with bracket "I" one 2 1/4 stove bolt with button.

APPLICATION OF RADIATOR BRACKETS

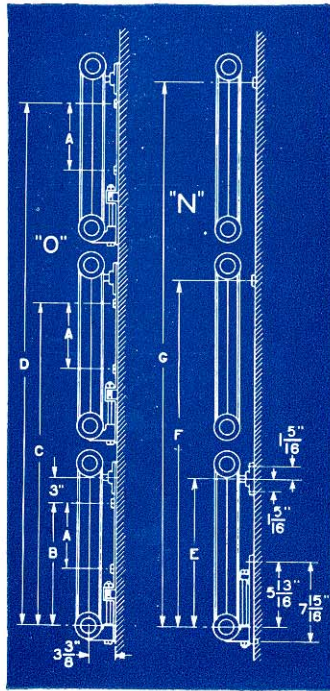

Triton Adjustable Brackets for Wall Radiation

"O" TYPE DIMENSIONS

Kind of Section	A	B	C	D
All Horizontal	0	6 15/16"	20 13/16"	34 11/16"
9' Vertical	8 1/16"	15"	44 1/4"	73 1/2"
7' Vertical	8 1/16"	15"	37 7/8"	60 3/4"

"N" TYPE DIMENSIONS

Kind of Section	E	F	G
All Horizontal	9 1/8"	23 3/8"	37 1/4"
9' Vertical	24 3/8"	53 5/8"	82 7/8"
7' Vertical	18"	40 7/8"	63 3/4"

Adjustments one inch either way from position shown.

TRITON ADJUSTABLE WALL BRACKETS

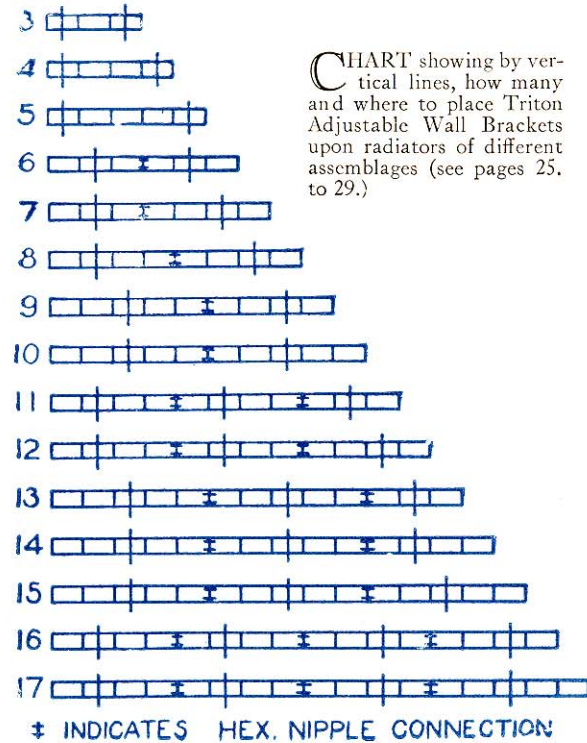

For longer assemblage combine the above figures as follows:

18.....10+8	22.....12+10	27.....12+15
19.....10+9	23.....10+13	28.....15+13
20.....10+10	24.....15+9	29.....15+14
21.....12+9	25.....15+10	30.....15+15
	26.....12+14	

CAPITOL RADIATOR BRACKET

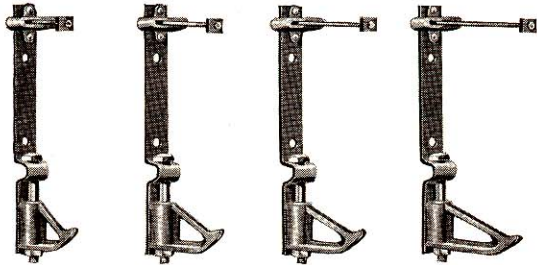

Adjustable, concealed; made to support 3, 4, 5, and 6 tube Capitol wall-hung radiators.

MEASUREMENTS OF CAPITOL RADIATOR BRACKETS

Wall to center of tapings
Dimension "A" in blueprint

ALL HEIGHTS

- 3 tube. 4 1/2 inches
- 4 tube. 5 13/32 inches
- 5 tube. 6 5/16 inches
- 6 tube. 7 7/32 inches

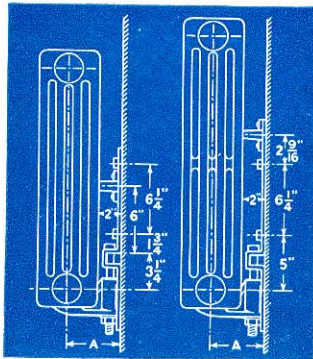

For radiators 20 and 23 inches high.

For radiators 26 inches high and more

NEW TU-BU-LUR RADIATOR HANGER

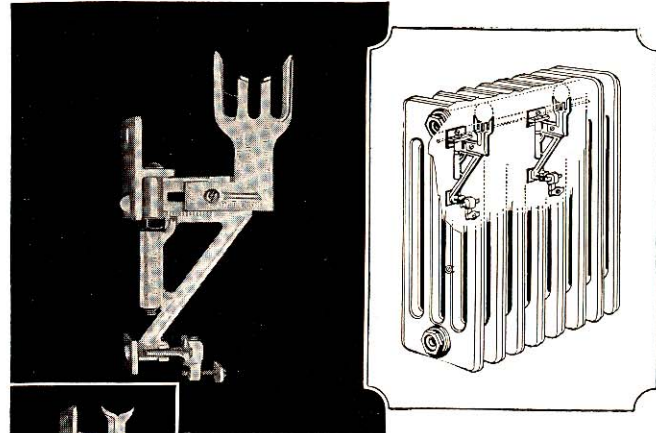

TU-BU-LUR Wall Hanger for wall radiators, with adjustable spacer.

The Little Giant TU-BU-LUR Bracket fits all tube type radiators, requires but one anchor bolt, and is not visible when in position. The only hanger providing adjustment in and out from wall; for vertical alignment; laterally in either direction; for raising or lowering radiator; to line radiator in exact plumb. In one style, three sizes. Of certified malleable iron, painted navy gray. Delivered complete ready to install.

- TU-BU-LUR No. 1 for 3, 4 & 5 Tube Radiators. \$1.35
- TU-BU-LUR No. 2 for 5, 6 & 7 Tube Radiators. 1.50
- TU-BU-LUR No. 3 for Wall Radiators. 1.35

LITTLE GIANT BOTTOM HUNG HANGERS

One bolt, two adjustment

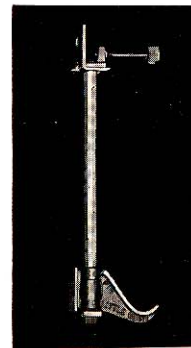

Style L holds radiator 1 7/8 inches from wall.

Style L for Wall Radiation and for 3 to 6 tube Radiators. \$0.85

Style L for Double Wall and for 7 tube Radiators. \$1.35

Style P for Wall Radiation and for 3 to 6 tube Radiators. \$1.15

Style P for Double Wall and for 7 tube Radiators. \$1.35

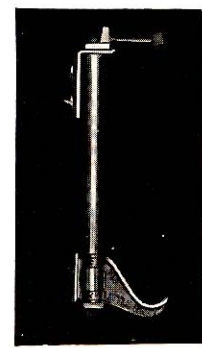

Style P holds radiator 2 1/4 inches from wall.

UNITED STATES RADIATOR CORPORATION

GENERAL OFFICES. DETROIT, MICHIGAN

BRANCH AND SALES OFFICES

*ATLANTA	764 Ponce De Leon Place, N. E.
*BALTIMORE	1147 Wicomico St.
*BIRMINGHAM, ALA.	1430 Second Ave., South
*BOSTON	260 Tremont St.
BUFFALO	303 Crosby Bldg.
*CAMBRIDGE, MASS.	233 Vassar St.
*CHICAGO	1401 Builders Building
*CINCINNATI	Exeter St. and McLean Ave.
*CLEVELAND	2294 Scranton Road
*COLUMBUS	478 Neilston St.
*DAVENPORT	1803 Rockingham Road
*DENVER	2439 Blake St.
*DES MOINES	400 Southwest Ninth St.
DETROIT	517 Dime Savings Bank Bldg.
*HARRISON, N. J.	Davis and Central Aves.
*INDIANAPOLIS	908 North Senate Ave.
*KANSAS CITY	1405 W. Eleventh St.
*LOS ANGELES	2120 E. 25th St.
*LOUISVILLE	1631 West High St.
*MASPETH, L. I., N. Y.	Grand Ave. and Creek St.
*MILWAUKEE	168 Corcoran Ave.
*NEW HAVEN	Railroad Ave. and New St.
*NEW ROCHELLE, N. Y.	Avenue E
NEW YORK	301-303 Architects Bldg.
*OMAHA	1017 North 21st St.
*PHILADELPHIA	22nd St. and Sedgley Ave.
*PITTSBURGH	941 Behan St., N. S.
*PORTLAND, ME.	2-4 Martyr St.
*PORTLAND, Ore.	16th St., North and Thurman St.
*PROVIDENCE	Allen's Ave., Foot of Oxford St.
*READING, PA.	Mifflin and Chestnut Sts.
*ROCHESTER	64 Chester St.
*ST. LOUIS	4004 Duncan Ave.
*ST. PAUL	688 Hampden Ave.
*SAN FRANCISCO	640 Second St.
*SEATTLE	1248 First Ave., South
*SPRINGFIELD, MASS.	North Main St.
*TROY	Center St., Green Island, N. Y.
WASHINGTON, D. C.	410 Bond Bldg.

*Assembly Plants located at points indicated by star.

Manufacturing Plants located in the following cities: Bristol, Pa.—Corry, Pa.—Detroit, Mich.—Dunkirk, N. Y.—Edwardsville, Ill.—Geneva, N. Y.—Waukegan, Ill.—West Newton, Pa.