

**Capitol
Boilers
and
Radiators**



UNITED STATES RADIATOR CORPORATION
DETROIT, MICHIGAN



Digitized by

The Association for Preservation Technology International

For the

Building Technology Heritage Library

<http://archive.org/details/buildingtechnologyheritagelibrary>



Capitol Boilers

UNITED STATES RADIATOR CORPORATION
DETROIT, MICHIGAN

STANDARD REQUIREMENTS

GUARANTEE

THE United States Radiator Corporation will give an absolute guarantee in writing that CAPITOL BOILERS will properly heat their full published amounts of "direct cast iron radiator loads in square feet," provided only that the boilers are connected to correctly installed systems and that the recognized standard requirements listed herein are followed. Should CAPITOL BOILERS not meet these conditions, the additional capacity necessary will be supplied "without charge" by the

UNITED STATES RADIATOR CORPORATION

A guarantee* of size of boiler for specified amount of Direct Cast Iron Radiation must be based upon certain standard requirements.

Direct Cast Iron Radiation: It is assumed that Direct Cast Iron Radiation will emit 240 B. t. u. per hour for steam, and 150 B. t. u. per hour for water, therefore, all radiation must be reduced to this heat emission basis.

The amount of radiation required on this basis shall be computed as outlined in our Engineering Data Book, or from methods adopted by either the Heating, Piping and Air Conditioning Contractors' National Association, or the American Society of Heating and Ventilating Engineers.

Corrections: Under ordinary conditions approximate corrections will reduce the following loads to their equivalent of Direct Cast Iron Radiation:

Wall Radiators on side walls, multiply by 1.25

Direct-Indirect, multiply by 1.25

Indirect, multiply by 1.50

Blast Coils—Determine condensation in pounds of steam per hour and multiply by 4.

Domestic Hot Water Supply—Where coils are used in fire box and small quantities of water heated. Storage tank capacity in gallons—for steam multiply by 2; for water multiply by 3.2.

Where large quantities of water are heated or indirect heaters used, requirements should be computed as outlined in our Engineering Data Book.

Allowances: The boiler size guaranteed for direct cast iron radiation includes allowances for heat loss of piping system and peak load.

Where the actual surface in square feet contained in piping system, reduced to its equivalent in Cast Iron Radiation, exceeds 25% of the Direct C. I. Radiation, add 80% of the extra surface to the Direct C. I. Radiation load when choosing boiler size.

Draft: The boiler shall be attached to a chimney providing sufficient draft to consume with proper combustion the required amount of fuel per hour.

Fuel: The size of boiler recommended is based upon the use of a free-burning coal not smaller than nut size and having a heat value of at least 13,000 B. t. u. When the coal to be used has a heat value less than 13,000 B. t. u. the Direct Cast Iron Radiation shall be multiplied by the factor corresponding to heat value of the coal.

Heat Value of Coal in B. T. U. per Pound	Factor
13,000	1.00
12,500	1.07
12,000	1.14
11,500	1.21
11,000	1.29
10,500	1.37
10,000	1.46
9,500	1.56
9,000	1.67
8,500	1.79

Oil Burner: The oil burner shall have a minimum capacity to burn per hour with proper combustion a quantity of oil containing 600 B. t. u. for each square foot of steam radiation and 375 B. t. u. for each square foot of water radiation as listed under direct cast iron radiator load for each boiler, except where otherwise specified in our catalogs.

Capitol Red Top Boilers

"A" Series

FOR EVERY FUEL
FOR SMALL HOMES AND BUILDINGS



UNITED STATES RADIATOR CORPORATION
DETROIT, MICHIGAN • U. S. A.

Thrifty Aristocrats of Heating

THE Capitol Red Top "A" Series Boiler is truly the "De Luxe" member of an outstanding line of heating boilers. Nothing has been overlooked to make it as fine a boiler as possible.

BEAUTY •

The appearance of the Red Top Boiler always wins praise. Glistening cobalt blue, cardinal red, nickel trimmings and a well-balanced design give to the Red Top an outstanding beauty. The jacket enamel is baked on. The doors are finished in porcelain enamel. The jacket is of heavy gauge steel, sturdy and easily assembled. To the smallest bolt and the most insignificant joint not a detail has been slighted.

ADVANCED DESIGN •

Not only has the Capitol Red Top a beautiful exterior. It possesses a superiority of design that achieves an inner quality in keeping with its outer appearance. The experienced heating engineer needs only a glance at the sections of the Red Top to realize that they are the reason why the Capitol Red Top gets more heat out of every kind of fuel, through longer fire travel and broader contact with water bearing areas. Capitol Red Top Boilers are made for burning coal, gas or oil. They are furnished in either jacketed or unjacketed styles.



HIGHEST QUALITY •

There is no mystery about the reputation for fine castings enjoyed by the United States Radiator Corporation. The constant testing and grading of molding and core sand, the rigid analysis of pig iron, the constant temperature control and inspection of every heat of molten iron, the expertness of the workmen, the precise machining and testing for tightness in every joint; these are the simple though important reasons for the fine castings that come from our plants.

ROCK WOOL INSULATION •

An important evidence of the quality of the Red Top Boiler is the insulation that is used. A thick blanket of rock wool hugs the sides, the top and even the back of the boiler. The rock wool is wire reinforced, cut to fit the boiler and affords the most effective insulation possible to secure. Note the illustration which shows how tightly and completely the insulation blankets the boiler.



IMPORTANT FEATURES OF CONSTRUCTION



Metal to metal contact between sections. Note in the illustration how ground joints make gas tight contacts between sections. Thus gas leakage and short circuiting between flues are prevented, assuring good combustion and easy regulation.

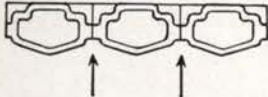

Ample flueways. No sharp turns. No gas restriction. The gases make easy turns, thus reducing friction. No smoking from the fire door.



Red Top Boilers are easy to clean. All flueways are without sharp angles and are of smooth surfaces. Fully accessible from the large front cleanout door.

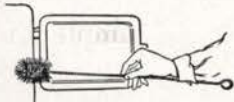

No small part of the ease of operation of the Red Top Boiler is due to the type of grate construction used. Only the very smallest effort is needed to operate them. They cannot be jarred nor forced from position at any time, yet their removal from the boiler is easily accomplished.



Doors and sections make gas-tight contact on ground joints. A cool conveniently shaped fire door handle is provided.



All doors except base door have liners. Liners prevent warping of doors and reduce heat losses.



The Red Top Boiler is noted for its steady water line. Controlled internal water circulation and large nipple ports insure complete separation of water and steam.



FIRE-TRAVEL "A" SERIES RED TOP BOILER



The cutaway view of the fire travel of the Red Top "A" Series Boiler illustrates many of the special features mentioned above and on the opposite page. ★ Of great importance to the user of the Red Top Boiler is the conservative manner in which the boiler is rated. The performance of every boiler is backed by Capitol Guaranteed Heating, a written guarantee to you of the capacity of the boiler installed. For details see "Standard Requirements."



R A T I N G S A N D D A T A

"A" SERIES FOR ALL FUELS



RATINGS SQUARE FEET

Boiler No.	STEAM		WATER	
	Capacity ②	① Direct Cast Iron Radiator Loads	Capacity ②	① Direct Cast Iron Radiator Loads
A-6	575	280	975	460
A-7	750	355	1275	585
A-8	925	430	1575	710
A-9	1100	505	1875	835
A-10	1275	580	2175	960
A-11	1450	655	2475	1085

① See Guarantee and Standard Requirements.
 ② Use Direct Cast Iron Radiator Loads Sq. Ft. for selection of boiler size.
 Height, including trimmings, 59 5/8", width 32 7/8".
 Height of water line 42 1/2".
 Equipped with combination top and back outlet smokehood.

"A" SERIES—OIL-BURNING TYPE



RATINGS SQUARE FEET

Boiler No.	STEAM		WATER	
	Capacity ②	① Direct Cast Iron Radiator Loads	Capacity ②	① Direct Cast Iron Radiator Loads
A-06	575	280	975	460
A-07	750	355	1275	585
A-08	925	430	1575	710
A-09	1100	505	1875	835
A-010	1275	580	2175	960
A-011	1450	655	2475	1085

① See Guarantee and Standard Requirements.
 ② Use Direct Cast Iron Radiator Loads Sq. Ft. for selection of boiler size.
 Height, including trimmings, 59 5/8", width, 32 7/8".
 Height of water line, 42 1/2".
 Clearance between grate lugs 15 1/2".
 Equipped with combination top and back outlet smokehood.

BOILER DATA

Boiler No.	Grate Area Sq. Ft.	Coal Capacity Cu. Ft.	Outlets③		Inlets③		Min. Chimney Dimensions③	
			Flue In.	Height Feet	Flue In.	Height Feet	Flue In.	Height Feet
A-6	1.96	3.04	1-4" & 1-3"	2-3"	8x12	30		
A-7	2.45	3.86	1-4" & 1-3"	2-3"	8x12	30		
A-8	2.94	4.68	1-4" & 1-3"	2-3"	8x12	35		
A-9	3.43	5.47	1-4" & 1-3"	2-3"	8x12	35		
A-10	3.92	6.32	1-4" & 1-3"	2-3"	8x12	35		
A-11	4.41	7.07	1-4" & 1-3"	2-3"	8x12	40		

③ Applies also to Oil Burning type.

DIMENSIONS (Inches)

Boiler No.	A	H	I④	Q
A-6, A-06	16	10 1/8	7	22 5/8
A-7, A-07	20	14 1/8	7	26 5/8
A-8, A-08	24	10 1/8	15	30 5/8
A-9, A-09	28	14 1/8	15	34 5/8
A-10, A-010	32	18 1/8	15	38 5/8
A-11, A-011	36	22 1/8	15	42 5/8

The above dimensions are subject to slight variations in assembly. Ashpit dimensions are given below.
 ④ Distance between 1st and 2nd flow tapping.

ASSEMBLY

A-6, A-06	F-T-B	A-9, A-09	F-H-T-V-B
A-7, A-07	F-H-T-B	A-10, A-010	F-M-T-V-B
A-8, A-08	F-T-V-B	A-11, A-011	F-H-M-T-V-B

KEY TO SECTIONS

F—Front	T—Tapped Double Middle
H—Single Middle	with flow tapping only.
M—Plain Double Middle	V—Double Rear Flue
	B—Back

TAPPINGS

The 4" flow tapping is located in the T section and the 3" flow tapping in the B section. Two 3" return tappings are located on the rear face of the back section. One 2" hot water supply heater tapping is located on the rear face of the back section. Untapped bosses for Taco Heaters supplied on all sections on left hand side and on all but front section on right hand side. Jacket provided with knockouts on both sides.

ASHPIT DIMENSIONS (INCHES)—"A" SERIES

Front edge of pit should be about 3" from front face of base front.

	"A"	"B"
A-6	23 1/2	16 1/4
A-7	23 1/2	20 1/4
A-8	23 1/2	24 1/4
A-9	23 1/2	28 1/4
A-10	23 1/2	32 1/4
A-11	23 1/2	36 1/4

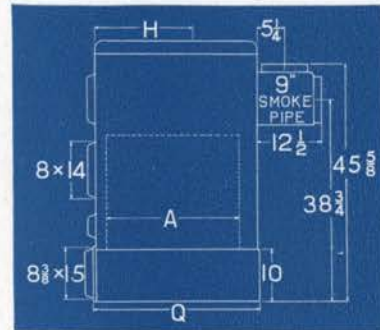
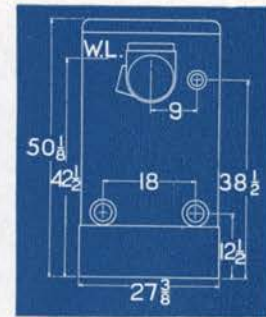

For all fuels

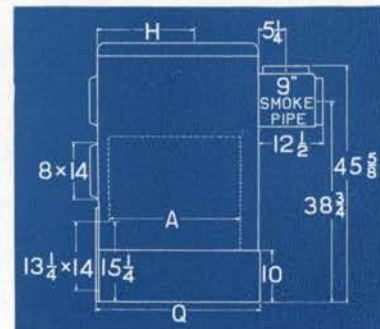

Oil-Burning Type

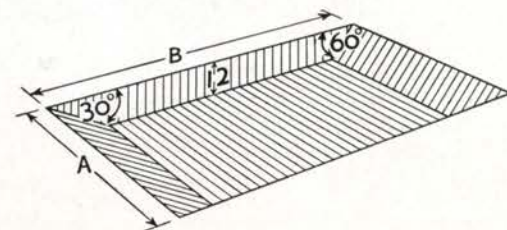

Capitol Red Top Boilers

"B" Series

FOR EVERY FUEL
FOR RESIDENCES, STORES, ETC.



UNITED STATES RADIATOR CORPORATION
DETROIT, MICHIGAN • U. S. A.

Thrifty Aristocrats of Heating

CAPITOL Red Top "B" Series Boilers look what they are—aristocrats. Expertly designed, carefully made in a modern plant and fashionably dressed, they fully embody the most modern of proven good practice in the heating field. Note the many features of superiority described below.

BEAUTY •



Back of front section The appearance of the Red Top Boiler always wins praise. Glistening cobalt blue, cardinal red, nickel trimmings and a well balanced design give to the Red Top an outstanding beauty. The jacket enamel is baked on. The doors are finished in porcelain enamel. The jacket is of heavy gauge steel, sturdy and easily assembled. To the smallest bolt and the most insignificant joint not a detail has been slighted.



Tapped middle section

ROCK WOOL INSULATION •

An important evidence of the quality of the Red Top Boiler is the insulation that is used. A thick blanket of rock wool hugs the sides, the top and even the back of the boiler. The rock wool is wire reinforced, cut to fit the boiler and affords the most effective insulation possible to secure.



HIGHEST QUALITY •

There is no mystery about the reputation for fine castings enjoyed by the United States Radiator Corporation. The constant testing of molding and core sand, the rigid analysis of pig iron, the constant temperature control and inspection of every heat of molten iron, the expertness of the workmen, the precise machining and testing for tightness in every joint; these are the simple though important reasons for the fine castings that come from our plants.

ADVANCED DESIGN •

Not only has the Capitol Red Top a beautiful exterior. It possesses a superiority of design that achieves an inner quality in keeping with its outer appearance. The experienced engineer needs only to glance at the sections of the Capitol Red Top "B" Series Boiler illustrated on this page to realize that they are the reason why the Red Top gets more heat out of every kind of fuel, whether coal, gas or oil. They are furnished in jacketed or unjacketed styles.



Rear flue section



Front of back section

IMPORTANT FEATURES OF CONSTRUCTION



Metal to metal contact between sections. Note in the illustration how ground joints make gas tight contacts between sections. Thus gas leakage and short circuiting between flues are prevented, assuring good combustion and easy regulation.



Ample flueways. No sharp turns. No gas restriction. The gases make easy turns, thus reducing friction. No smoking from the fire door.



Red Top Boilers are easy to clean. All flueways are without sharp angles and are of smooth surfaces. Fully accessible from the large front cleanout doors.



No small part of the ease of operation of the Red Top Boiler is due to the type of grate construction used. Only the very smallest effort is needed to operate them. And they cannot be jarred nor forced from position at any time. Yet their removal from the boiler is easily accomplished.



Doors and sections make gas tight contact on ground joints. A cool conveniently shaped fire door handle is provided.



All doors except base door have liners. Liners prevent warping of doors and reduce heat losses.



The Red Top Boiler is noted for its steady water line. Controlled internal water circulation and large nipple ports insure complete separation of water and steam.

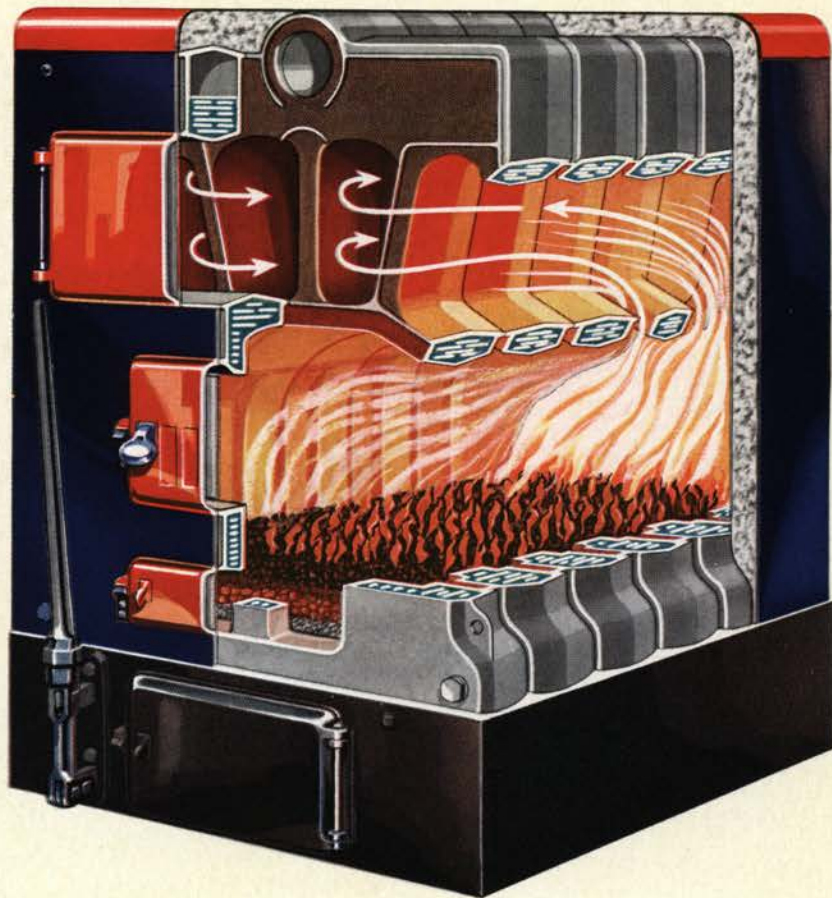

FIRE TRAVEL "B" SERIES RED TOP BOILER

The cutaway view of the fire travel of the Red Top "B" Series Boiler illustrates many of the special features mentioned above and on the opposite page. ★ Of great importance to the user of a Red Top Boiler is the conservative manner in which the boiler is rated. The performance of every boiler is backed by Capitol Guaranteed Heating, a written guarantee to you of the capacity of the boiler installed. For details see "Standard Requirements." ★ The diagram at the left shows how smokeless combustion in the Smokeless "B" Series Boiler is accomplished. The curtain section has air inlets which are scientifically placed and designed to supply the additional air necessary to ignite the smoky gases given off from bituminous coals.

R A T I N G S A N D D A T A

"B" SERIES FOR ALL FUELS AND SMOKELESS TYPES†

RATINGS SQUARE FEET



Boiler No.	STEAM		WATER	
	Capacity ②	① Direct Cast Iron Radiator Loads	Capacity ②	① Direct Cast Iron Radiator Loads
B-6	1200	550	1980	910
B-7	1500	735	2475	1215
B-8	1800	920	2970	1520
†B-9	2100	1105	3465	1825
†B-10	2400	1290	3960	2130
†B-11	2700	1475	4455	2435
†B-12	3000	1660	4950	2740
†B-13	3300	1845	5445	3045
†B-14	3600	2030	5940	3350

① See Guarantee and Standard Requirements.
 ② Use Direct Cast Iron Radiator Loads Sq. Ft. for selection of Boiler size.
 Height, including trimmings, 65 $\frac{3}{8}$ "; width, 42 $\frac{5}{8}$ ".
 Height of water line, 46 $\frac{1}{2}$ ".
 Equipped with combination top and back outlet smokehood.
 † Sizes marked † furnished in smokeless type. B-13 and B-14 not furnished in all fuels type.

BOILER DATA

Boiler No.	Grate Area Sq. Ft. ③	Coal Capacity Cu. Ft. ④	Outlets ⑤		Inlets ⑥		Min. Chimney Flue In.	Chimney Dimensions ⑦ Height Feet
			⑤	⑤	⑥	⑥		
B-6	3.60	6.11	⑥ 1-4"	2-4"	2-4"	2-4"	8x12	35
B-7	4.50	7.77	⑥ 1-4"	2-4"	2-4"	2-4"	12x12	35
B-8	5.40	9.44	2-4"	2-4"	2-4"	2-4"	12x12	35
B-9	6.30	11.13	2-4"	2-4"	2-4"	2-4"	12x12	40
B-10	7.20	12.73	2-4"	2-4"	2-4"	2-4"	12x16	40
B-11	8.10	14.44	2-4"	2-4"	2-4"	2-4"	12x16	45
B-12	9.00	16.13	2-4"	2-4"	2-4"	2-4"	12x16	45
B-13	9.90	17.83	2-4"	2-4"	2-4"	2-4"	12x16	50
B-14	10.80	19.53	3-4"	2-4"	2-4"	2-4"	12x16	50

③ Applies to All Fuels and Smokeless types.
 ④ Applies to All Fuels type.
 ⑤ Applies to all types.

DIMENSIONS (Inches)

Boiler No.	A	H	I	J	Q
B-6	20	12 $\frac{1}{8}$	26 $\frac{5}{8}$
B-7, B-07	25	12 $\frac{1}{8}$	31 $\frac{5}{8}$
B-8, B-08	30	12 $\frac{1}{8}$	18 $\frac{3}{4}$...	36 $\frac{5}{8}$
B-9, B-09	35	12 $\frac{1}{8}$	23 $\frac{3}{4}$...	41 $\frac{5}{8}$
B-10, B-010	40	12 $\frac{1}{8}$	28 $\frac{3}{4}$...	46 $\frac{5}{8}$
B-11, B-011	45	17 $\frac{1}{8}$	28 $\frac{3}{4}$...	51 $\frac{5}{8}$
B-12, B-012	50	22 $\frac{1}{8}$	28 $\frac{3}{4}$...	56 $\frac{5}{8}$
B-13, B-013	55	27 $\frac{1}{8}$	28 $\frac{3}{4}$...	61 $\frac{5}{8}$
B-14, B-014	60	12 $\frac{1}{8}$	20	28 $\frac{3}{4}$	66 $\frac{5}{8}$

The above dimensions are subject to slight variations in assembly. Ashpit dimensions are given below.

ASSEMBLY—All Fuels and Oil Burning Types

B-6	F-T-B	B-11, B-011	F-H-T-M-V-B
B-7, B-07	F-T-H-B	B-12, B-012	F-M-T-M-V-B
B-8, B-08	F-T-M-B	B-013	F-H-M-T-V-V-B
B-9, B-09	F-T-H-V-B	B-014	F-T-M-T-V-V-B
B-10, B-010	F-T-M-V-B		

ASSEMBLY—Smokeless Type

B-9	F-T-H-C-B	B-12	F-M-T-C-V-B
B-10	F-T-M-C-B	B-13	F-H-M-T-C-V-B
B-11	F-H-T-M-C-B	B-14	F-T-M-T-C-V-B

KEY TO SECTIONS

F—Front
 H—Single Middle
 M—Plain Double Middle
 C—Curtain
 T—Tapped Double Middle with flow tapping only
 V—Rear Flue
 B—Back

TAPPINGS

Flow tappings on the B Series are in the T and B sections only.

⑥ If two flow tappings are desired, the plug may be removed from the 4" tapping in the back section. Two 4" return tappings are located on the rear face of the back section.

One 2" hot water supply heater tapping is located on the rear face of the back section.

Untapped bosses for Taco Heaters are supplied on all sections on left hand side and on all but front section on right hand side. Jacket is provided with knockouts on both sides.

ASHPIT DIMENSIONS (INCHES) —"B" SERIES

Front edge of pit should be about 3" from front face of base front.

	"A"	"B"
B-6	33 $\frac{1}{2}$	20 $\frac{1}{4}$
B-7	33 $\frac{1}{2}$	25 $\frac{1}{4}$
B-8	33 $\frac{1}{2}$	30 $\frac{1}{4}$
B-9	33 $\frac{1}{2}$	35 $\frac{1}{4}$
B-10	33 $\frac{1}{2}$	40 $\frac{1}{4}$
B-11	33 $\frac{1}{2}$	45 $\frac{1}{4}$
B-12	33 $\frac{1}{2}$	50 $\frac{1}{4}$
B-13	33 $\frac{1}{2}$	55 $\frac{1}{4}$
B-14	33 $\frac{1}{2}$	60 $\frac{1}{4}$

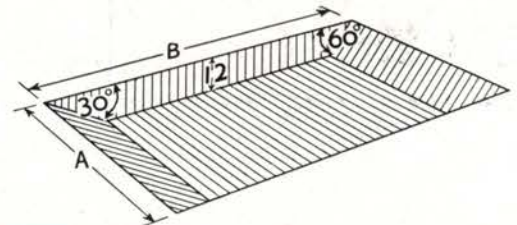

"B" SERIES—OIL BURNING TYPE

RATINGS SQUARE FEET



Boiler No.	STEAM		WATER	
	Capacity ②	① Direct Cast Iron Radiator Loads	Capacity ②	① Direct Cast Iron Radiator Loads
B-07	1500	735	2475	1215
B-08	1800	920	2970	1520
B-09	2100	1105	3465	1825
B-010	2400	1290	3960	2130
B-011	2700	1475	4455	2435
B-012	3000	1660	4950	2740
B-013	3300	1845	5445	3045
B-014	3600	2030	5940	3350

① See Guarantee and Standard Requirements.
 ② Use Direct Cast Iron Radiator Loads Sq. Ft. for selection of boiler size.
 Height, including trimmings, 65 $\frac{3}{8}$ "; width, 42 $\frac{5}{8}$ ".
 Height of water line, 46 $\frac{1}{2}$ ".
 Clearance between grate lugs, 23 $\frac{3}{4}$ ".
 Equipped with combination top and back outlet smokehood.

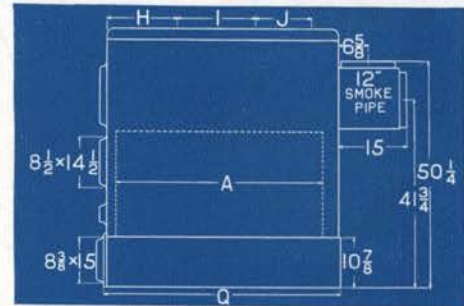
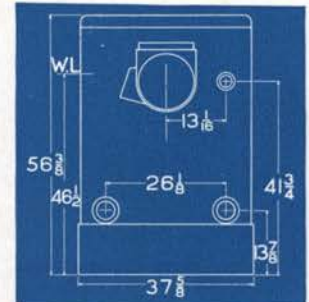
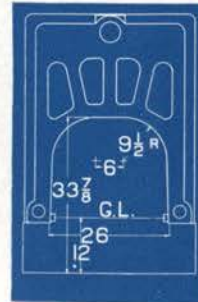

For all fuels and smokeless type

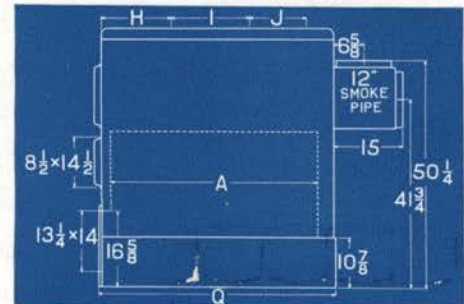

Oil burning type

Capitol Red Top Boilers

"C" Series

FOR EVERY FUEL
AND FOR LARGE BUILDINGS



UNITED STATES RADIATOR CORPORATION
DETROIT, MICHIGAN · U. S. A.

Thrifty Heating

CAPITOL Red Top "C" Series Boilers are built for large heating loads. They are used in apartments, schools, business buildings, and, in batteries, for even the largest commercial structures. And they are designed to handle these tasks with the utmost economy.



ADVANCED DESIGN •

Your attention is directed to the illustration on this page which clearly shows the construction of the sections which form the "C" Series Red Top Boiler. The experienced engineer needs only a glance at them to realize that they are capable of highly efficient operation. "C" Series Boilers are equally adaptable to either coal, gas or oil fuels. They are furnished in jacketed and unjacketed styles.

HIGHEST QUALITY •

There is no mystery about the reputation for fine castings enjoyed by the United States Radiator Corporation. The constant testing of molding and core sand, the rigid analysis of pig iron, the constant temperature control and inspection of every heat of molten iron, the expertness of the workmen, the precise machining and testing for tightness in every joint; these are the simple though important reasons for the fine castings that come from our plants.

ROCK WOOL INSULATION •

Especially important in large boilers is the quality of the insulation that is used beneath the jacket. An evidence of the quality of the Red Top Boiler is the fact that rock wool insulation is used.

A thick blanket of this most efficient insulation hugs the sides, top and even the back of the boiler. The rock wool is wire reinforced, cut to fit the boiler and affords the most effective insulation possible to secure.

BEAUTY •

The appearance of the Red Top Boiler always wins approval. Glistening cobalt blue, cardinal red, nickel trimmings and a well balanced design give to the Red Top an outstanding beauty. The jacket enamel is baked on. The jacket is of heavy gauge steel, sturdy and easily assembled. For purely utilitarian installations, where appearance is not a factor, the boiler can be obtained without jacket and insulation.

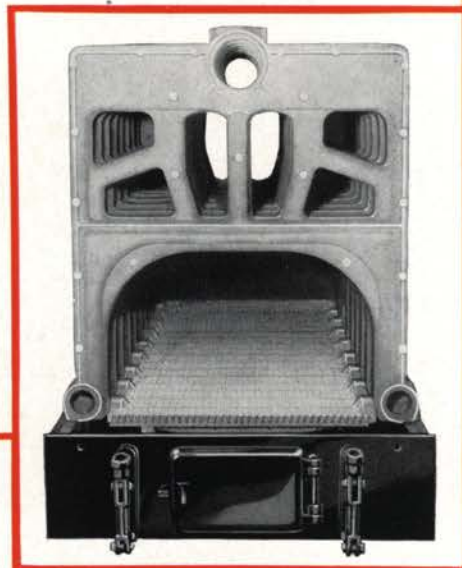

IMPORTANT FEATURES OF CONSTRUCTION



Metal to metal contact between sections. Note in the illustration how ground joints make gas tight contacts between sections. Thus gas leakage and short circuiting between flues are prevented, assuring good combustion and easy regulation.



Ample flueways. No sharp turns. No gas restriction. The gases make easy turns, thus reducing friction. No smoking from the fire door.



Red Top Boilers are easy to clean. All flueways are without sharp angles and are of smooth surfaces. Fully accessible from the large front cleanout doors.



No small part of the ease of operation of the Red Top Boiler is due to the type of grate construction used. Only the very smallest effort is needed to operate them. And they cannot be jarred nor forced from position at any time. Yet their removal from the boiler is easily accomplished.



Doors and sections make gas tight contact on ground joints. A cool conveniently shaped fire door handle is provided.



The Red Top Boiler is noted for its steady water line. Controlled internal water circulation and large nipple ports insure complete separation of water and steam.

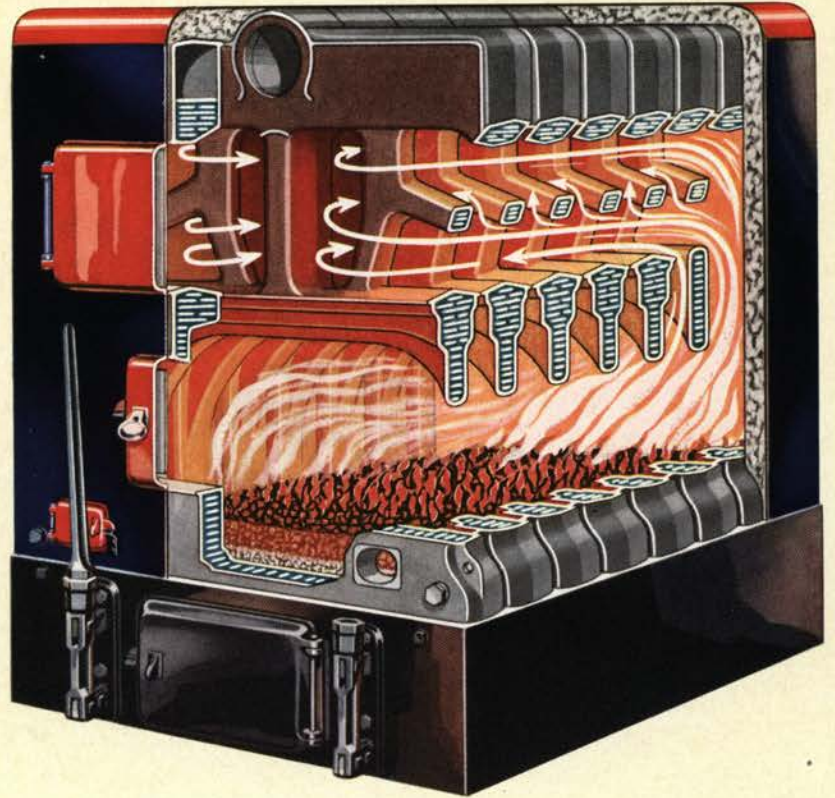
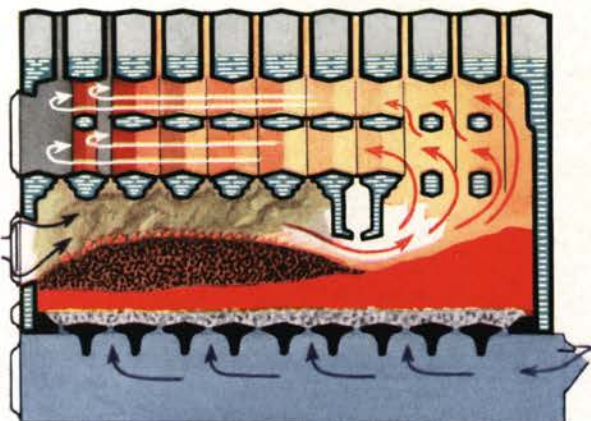

FIRE-TRAVEL "C" SERIES RED TOP BOILER

The cutaway view of the fire travel of the Red Top "C" Series Boiler illustrates many of the special features mentioned above and on the opposite page. ★ Of great importance to the user of a Red Top Boiler is the conservative manner in which the boiler is rated. The performance of every boiler is backed by Capitol Guaranteed Heating, a written guarantee to you of the capacity of the boiler installed. For details see "Standard Requirements." ★ At the left is shown the construction used to secure smokeless combustion in the "C" Series Boiler. The curtain sections have air inlets which are scientifically placed and designed to supply the additional air so that the smoky gases are completely ignited as they pass beneath them. The proper firing of this series boiler is so simple that even the most inexperienced operator can achieve smokeless results.

R A T I N G S A N D D A T A

"C" SERIES FOR ALL FUELS AND SMOKELESS TYPES†

RATINGS SQUARE FEET



Boiler No.	STEAM		WATER	
	Capacity ②	①Direct Cast Iron Radiator Loads	Capacity ②	①Direct Cast Iron Radiator Loads
C-12	4700	1865	7760	3080
†C-14	5600	2375	9240	3920
†C-16	6500	2930	10730	4840
†C-18	7300	3485	12050	5750
†C-20	8000	4050	13200	6680
†C-22	8700	4575	14360	7550
†C-24	9300	5045	15350	8320
†C-26	9900	5455	16335	9000
†C-28	10500	5805	17325	9580

① See Guarantee and Standard Requirements.
 ② Use Direct Cast Iron Radiator Loads Sq. Ft. for selection of boiler size.
 Height including trimmings 73 3/4", width 54 1/4".
 Height of water line 55".
 Equipped with combination top and back outlet smokehood.
 † Sizes marked † furnished in smokeless type.

BOILER DATA

Boiler No.	Grate Area Sq. Ft.	Coal Capacity Cu. Ft.	Outlets		Inlets		Min. Chimney Dimensions	
			⑤	⑥	⑦	⑧	Flue In.	Height Feet
C-12	10.12	15.15	2-5"	2-6"	16x20	50		
C-14	12.18	18.53	3-5"	2-6"	20x20	55		
C-16	14.23	21.92	3-5"	2-6"	20x20	60		
C-18	16.28	25.30	4-5"	2-6"	20x24	65		
C-20	18.34	28.68	4-5"	2-6"	20x24	70		
C-22	20.39	32.06	4-5"	2-6"	20x24	75		
C-24	22.45	35.30	4-5"	2-6"	24x28	75		
C-26	②2.10	34.75	5-5"	2-6"	24x28	80		
C-28	②2.10	34.75	5-5"	2-6"	24x28	90		

⑤ Applies to All Fuels and Smokeless types.
 ⑥ Applies to All Fuels type.
 ⑦ Applies to all types.
 ⑧ C-26 and C-28 Coal Burning Boilers are equipped with a bridgwall plate designed for a fire brick lining.

DIMENSIONS (Inches)

Boiler No.	DIMENSIONS (Inches)						L	Q
	A	H	I	J	K	G		
C-12, C-012	39 3/8	10 1/16	24	47 5/8	
C-14, C-014	47 3/8	10 1/16	16	16	55 5/8	
C-16, C-016	55 3/8	10 1/16	16	24	63 5/8	
C-18, C-018	63 3/8	10 1/16	16	16	16	..	71 5/8	
C-20, C-020	71 3/8	10 1/16	16	24	16	..	79 5/8	
C-22, C-022	79 3/8	10 1/16	16	32	16	..	87 5/8	
C-24, C-024	87 3/8	10 1/16	16	40	16	..	95 5/8	
C-26, C-026	②95 3/8	10 1/16	16	16	32	16	103 5/8	
C-28, C-028	②103 3/8	10 1/16	16	16	40	16	111 5/8	

② Distance between 4th and 5th flow tappings, C-26 and C-28.
 ③ Measured to the forward face of the bridgwall lining in coal burning boilers, 86".
 The above dimensions are subject to slight variations in assembly. Ashpit dimensions are given below.

ASSEMBLY—All Fuels and Oil-burning Types

C-12 F-T-M-M-X-B	C-20 F-A-M-T-M-M-T-X-X-B
C-14 F-T-M-T-M-X-B	C-22 F-A-M-T-M-M-M-T-X-X-B
C-16 F-A-M-T-M-M-X-B	C-24 F-A-M-T-M-M-M-T-X-X-B
C-18 F-A-M-T-M-T-X-X-B	C-26 F-A-M-T-M-T-M-M-M-X-X-X-B
C-28 F-A-M-T-M-T-M-M-M-X-X-X-B	

ASSEMBLY—Smokeless Type

C-14 F-T-M-K-C-X-B	C-22 F-A-M-T-M-M-C-K-X-X-B
C-16 F-A-M-T-C-C-X-B	C-24 F-A-M-T-M-M-M-C-K-X-X-B
C-18 F-A-M-T-C-K-X-X-B	C-26 F-A-M-T-M-T-C-C-M-X-X-X-B
C-20 F-A-M-T-M-C-K-X-X-B	C-28 F-A-M-T-M-T-M-C-C-M-X-X-X-B

KEY TO SECTIONS

F—Front	K—Tapped Curtain with flow tapping only
A—Tapped Front Flue with flow tapping only	T—Tapped Middle with flow tapping only
M—Plain Middle	X—Tapped Rear Flue with flow tapping only
C—Curtain	
B—Back	

TAPPINGS

Flow tappings on the C Series are in A, T, K and X sections. Where there are two or more X sections, the X section second from rear is bushed for the second safety valve where two safety valves are required. Where two are not required this tapping is plugged. Two 6" return tappings are on the rear face of the back section. One 2 1/2" Hot Water Supply Heater Tapping is on the face of back section. Untapped bosses for Taco Heaters supplied on all sections on left hand side and on all but front section on right hand side. Jacket provided with knockouts on both sides.

"C" SERIES—OIL BURNING TYPE

RATINGS SQUARE FEET



Boiler No.	STEAM		WATER	
	Capacity ②	①Direct Cast Iron Radiator Loads	Capacity ②	①Direct Cast Iron Radiator Loads
C-012	4700	1865	7760	3080
C-014	5600	2375	9240	3920
C-016	6500	2930	10730	4840
C-018	7300	3485	12050	5750
C-020	8000	4050	13200	6680
C-022	8700	4575	14360	7550
C-024	9300	5045	15350	8320
C-026	9900	5455	16335	9000
C-028	10500	5805	17325	9580

① See Guarantee and Standard Requirements.
 ② Use Direct Cast Iron Radiator Loads Sq. Ft. for selection of boiler size.
 Height, including trimmings, 73 3/4", width 54 1/4".
 Height of water line, 55".
 Clearance between grate lugs, 34 3/8".
 Equipped with combination top and back outlet smokehood.

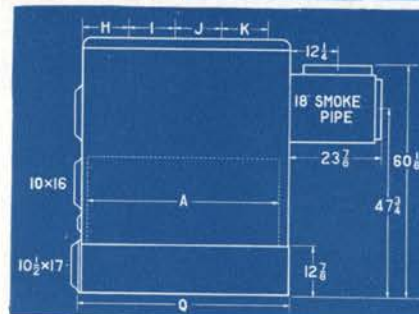
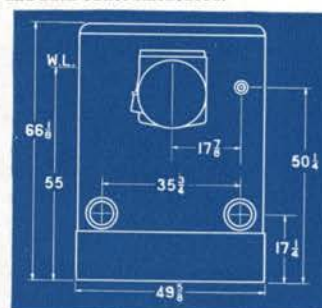
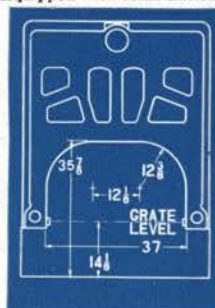

All fuels and smokeless type

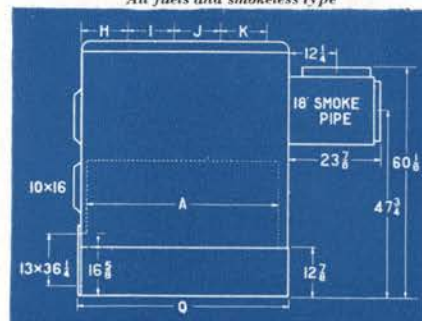

Oil-burning type

ASHPIT DIMENSIONS (INCHES)—"C" SERIES—Front edge of pit should be about 3" from front face of base front.

	"A"	"B"		"A"	"B"
C-12	45 1/2	41 1/4	C-22	45 1/2	81 1/4
C-14	45 1/2	49 1/4	C-24	45 1/2	89 1/4
C-16	45 1/2	57 1/4	C-26	45 1/2	82 3/4
C-18	45 1/2	65 1/4	C-28	45 1/2	82 3/4
C-20	45 1/2	73 1/4			

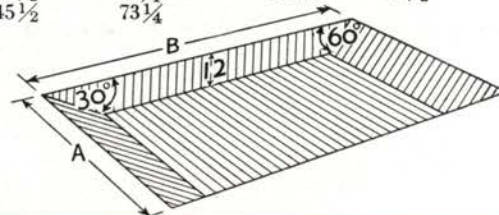

CAPITOL BLACK TOP BOILERS

A
FINE BOILER FOR
SMALL HOMES
AND
BUILDINGS

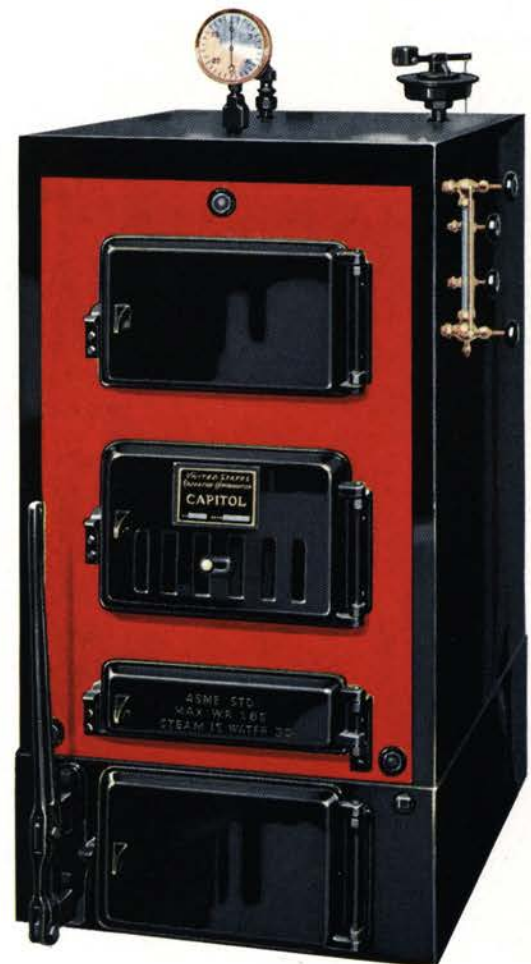

UNITED STATES RADIATOR CORPORATION
DETROIT, MICHIGAN · U. S. A.

The Capitol Black Top Boiler



For All Fuels

ADVANCED DESIGN •

The Capitol Black Top Boiler embodies all the latest improvements of boiler design. The boiler is made to get more heat out of every kind of fuel. The experienced heating engineer needs only to glance at the sections of the Black Top Boiler to realize that they are the reason why the boiler operates so efficiently. Capitol Black Top Boilers are made for burning coal, gas or oil. Furnished in jacketed and unjacketed styles.

HIGHEST QUALITY •

There is no mystery about the reputation for fine castings enjoyed by the United States Radiator Corporation. The constant testing and grading of molding and core sand, the rigid



analysis of pig iron, the constant temperature control and inspection of every heat of molten iron, the expertness of the workmen, the precise machining and testing for tightness in every joint; these are the simple though important reasons for the fine castings that come from our plants.

BEAUTY •

The Capitol Black Top Boiler is of striking appearance. The jet black sides, top and base, with the cardinal red panel in the front create a pleasing contrast.

The jacket is of heavy gauge steel, very sturdy and easily assembled. The jacket may be erected either before or after the boiler is connected to the piping.

ROCK WOOL INSULATION •

Long fibre rock wool insulation is used. The full inch thick blanket of rock wool hugs the top and sides of the boiler, and is accurately cut to fit.

Oil Burning Type



IMPORTANT FEATURES OF CONSTRUCTION



Metal to metal contact between sections. Note in the illustration how ground joints make gas tight contacts between sections. Thus gas leakage and short circuiting between flues are prevented, assuring good combustion and easy regulation.

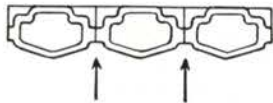

Ample flueways. No sharp turns. No gas restriction. The gases make easy turns, thus reducing friction. No smoking from the fire door.



Black Top Boilers are easy to clean. All flueways are without sharp angles and are of smooth surfaces. Fully accessible from the large front cleanout door.



No small part of the ease of operation of the Black Top Boiler is due to the type of grate construction used. Only the very smallest effort is needed to operate them. And they cannot be jarred nor forced from position at any time. Yet their removal from the boiler is easily accomplished.



Doors and sections make gas tight contact on ground joints. All doors except base door have liners. Liners prevent warping and reduce heat losses.



The Black Top Boiler is noted for its steady water line. Controlled internal water circulation and large nipple ports insure complete separation of water and steam.



FIRE-TRAVEL BLACK TOP BOILER



The cutaway view of the fire travel of the Black Top Boiler illustrates many of the special features mentioned above and on the opposite page.

Of great importance to the user of a Black Top Boiler is the conservative manner in which the boiler is rated. The performance of every boiler is backed by Capitol Guaranteed Heating, a written guarantee to you of the capacity of the boiler installed. For details see "Standard Requirements."





Ratings and Data



For All Fuels

Oil Burning Type

RATINGS SQUARE FEET

Boiler Number For All Fuels	Boiler Number Oil Burning Type	STEAM		WATER	
		Capacity ②	⊕Direct Cast Iron Rad. Load	Capacity ②	⊕Direct Cast Iron Rad. Load
6-A	06-A	575	280	975	460
7-A	07-A	750	355	1275	585
8-A	08-A	925	430	1575	710
9-A	09-A	1100	505	1875	835
10-A	010-A	1275	580	2175	960
11-A	011-A	1450	655	2475	1085

BOILER DATA

Boiler Number For All Fuels	Grate Area Sq. Ft.	Coal Capacity Cu. Ft.	⊕Min. Chimney Dimensions	
			Flue Inches	Height Feet
6-A	1.96	3.04	8x12	30
7-A	2.45	3.86	8x12	30
8-A	2.94	4.68	8x12	35
9-A	3.43	5.47	8x12	35
10-A	3.92	6.32	8x12	35
11-A	4.41	7.07	8x12	40

- ① See Guarantee and Standard Requirements.
 - ② Use Direct Cast Iron Radiator Loads Sq. Ft. for selection of boiler size.
 - ③ Also applies to Oil Burning Type.
- Height, including trimmings, 59 $\frac{5}{8}$ " , width, 32 $\frac{7}{8}$ " .
 Height of water line, 42 $\frac{1}{2}$ " .
 Clearance between grate lugs, 15 $\frac{1}{2}$ " .

OUTLETS AND INLETS

All Black Top Boilers have one 4" and one 3" outlet and two 3" inlets.

DIMENSIONS (Inches)

Boiler No. For All Fuels	Boiler No. Oil Burning Type	A	H	I	Q
6-A	06-A	16	10 $\frac{1}{8}$	7	21 $\frac{7}{8}$
7-A	07-A	20	14 $\frac{1}{8}$	7	25 $\frac{7}{8}$
8-A	08-A	24	10 $\frac{1}{8}$	15	29 $\frac{7}{8}$
9-A	09-A	28	14 $\frac{1}{8}$	15	33 $\frac{7}{8}$
10-A	010-A	32	18 $\frac{1}{8}$	15	37 $\frac{7}{8}$
11-A	011-A	36	22 $\frac{1}{8}$	15	41 $\frac{7}{8}$

The above dimensions are subject to slight variations in assembly.

ASSEMBLY

6-A|06-A|F-T-B || 8-A|08-A|F-T-V-B || 10-A|010-A|F-M-T-V-B
 7-A|07-A|F-H-T-B || 9-A|09-A|F-H-T-V-B || 11-A|011-A|F-H-M-T-V-B

KEY TO SECTIONS

F—Front. H—Single Middle. M—Plain Double Middle. T—Tapped Double Middle with flow tapping only. V—Double Rear Flue. B—Back.

TAPPINGS

The 4" flow tapping is located in the T section and the 3" flow tapping in the B section. Two 3" return tappings are located on the rear face of the back section. One 2" hot water supply heater tapping is located on the rear face of the back section. Untapped bosses for Taco Heaters supplied on all sections on left hand side and on all but front section on right hand side. Jacket provided with knockouts on both sides.

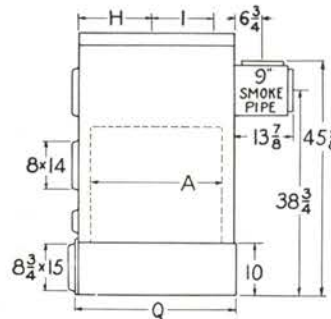

For all Fuels

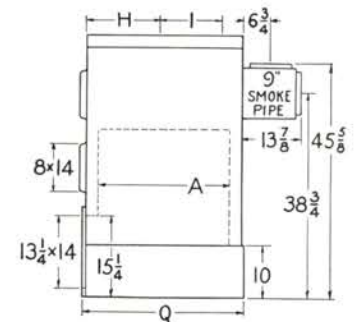
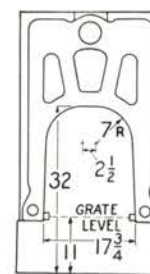
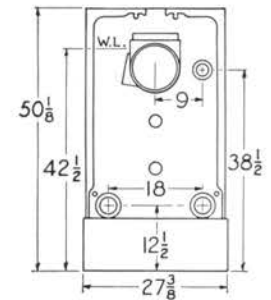

Oil Burning Type

ASHPIT DIMENSIONS (INCHES)—BLACK TOP BOILERS
 Front edge of pit should be about 3" from front face of base front.

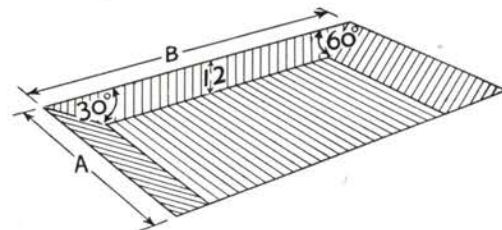

	"A"	"B"
6-A	23 $\frac{1}{2}$	16 $\frac{1}{4}$
7-A	23 $\frac{1}{2}$	20 $\frac{1}{4}$
8-A	23 $\frac{1}{2}$	24 $\frac{1}{4}$
9-A	23 $\frac{1}{2}$	28 $\frac{1}{4}$
10-A	23 $\frac{1}{2}$	32 $\frac{1}{4}$
11-A	23 $\frac{1}{2}$	36 $\frac{1}{4}$

Capitol

"O"
S
E
R
I
E
S



Oil Burning Boilers

A product of
Unit Engineering

The Boiler  ***The Burner***

**A Really
New Development
in Oil Burning
Boilers**

***is
designed
for***

**A Horizontally
Fired Burner of
Your Choice
Using
Low Priced Oils**

- *A new product engineered under test with the better burners.*
- *A new way to absorb heat.*
- *A new method of fire travel.*
- *A new internal water circulation.*
- *A new type wet base construction.*
- *A new compactness in size.*
- *A new beauty.*

Ask Your Dealer

BACKED BY

50 ***years of boiler building
experience!***

UNITED STATES RADIATOR CORPORATION
DETROIT, MICHIGAN

The Capitol "O" Series Boiler

Cast iron construction is used in the Capitol Oil Burning Boiler. Cast iron can be molded to the exact shapes to secure peak efficiency. Cast iron insures long boiler life.

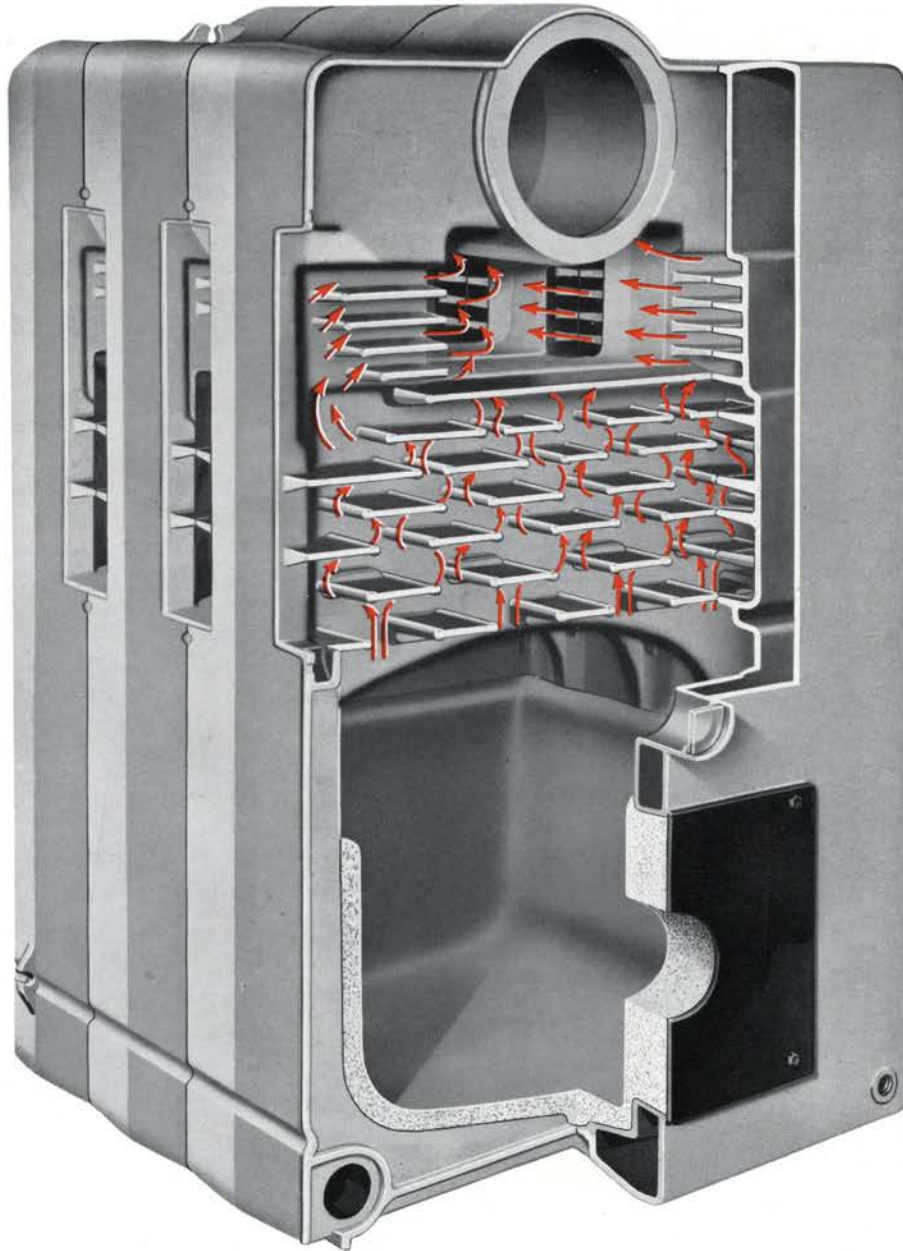

Extended Rib Type Heating Surface.
Large Combustion Chamber.
Low Draft Loss.
Quick Steaming.
Front or Rear Firing.

Wet Base Construction.
Ground Joints Between Sections.
Unique Gas Travel.
Positive Internal Water Circulation.
Large Steam Liberating Surface.
Compact Size.

New Achievements

FOREWORD It is a well established fact, that, far beyond the range of ordinary conditions of heat transfer, boiler water will absorb all the heat that can be brought to it from the heating surfaces, provided that good water circulation is maintained.

It is also known that, once heat is brought to the surface of the metal by the hot flue gases, the transfer of heat through the boiler walls is so nearly instantaneous that the metal itself will transmit more heat than can be brought to it.

The obstacle to speedier heat transfer is a layer of slow moving cooler gases which cling to the heat absorbing surfaces and act as insulators between the hotter gases and the boiler walls.

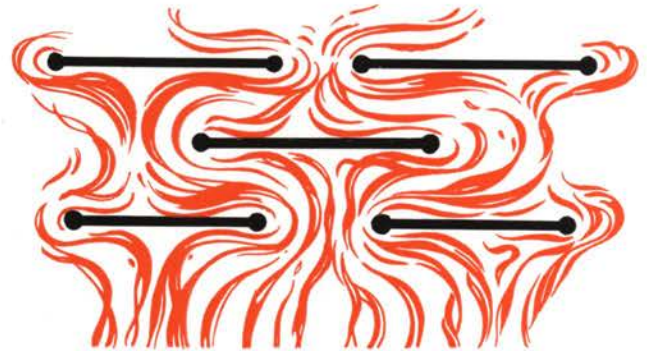
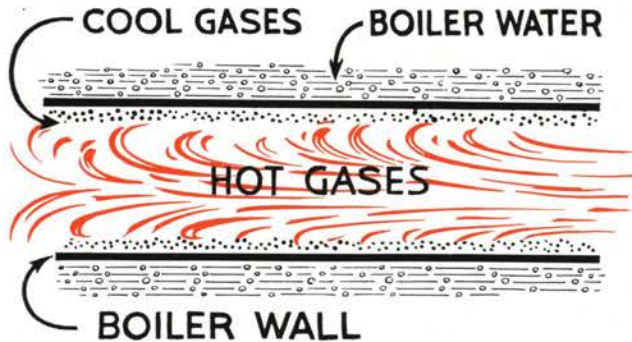

In the conventional type boiler

as illustrated above, the gases are of even temperature throughout as they enter the flueways. As they move along the flue, the layers nearest the heating surfaces give up most of their heat and become cooler than the center core of gases which have not been in contact with heat absorbing surfaces.

The friction created by the rubbing of the gases against the heat absorbing surfaces retards their speed. The center core of hot gases, having little frictional resistance, moves much faster. This fact has always prevented higher efficiencies because the central core of hot gases, potentially the most useful, speed through the boiler while the comparatively cool, ineffective layers next to the boiler walls cling obstinately and retard heat transfer.



A new way to absorb heat

In the "O" Series Capitol Oil Burning Boiler the flue gases rise upward between each section. After they have traveled through the passages created by the prime and ribbed heat absorbing surfaces they collect into a central flueway and make their exit from the boiler in the rear. On the face of each section are scientifically placed and proportioned cast iron ribs which are an integral part of the boiler casting. Note detailed illustration on page three.

As the hot gases from the combustion chamber meet the first row of ribs they give up their heat and become relatively cool. Their rubbing against the ribs creates sufficient friction to retard their velocity. The hotter gases which have not come into contact with the heat absorbing surfaces and have had nothing to retard them, move at a high velocity and therefore possess momentum.

The value of momentum is easily proven by a simple experiment. Direct a stream of hot water from a faucet into a pan of cold water. The hot water reaches the bottom of the pan immediately shoving the cold water aside because of its momentum.

thru New Methods

The value of momentum

This momentum literally dashes these hotter gases against the second row of heat absorbing ribs, displacing any cool gases that may be in contact with these surfaces.

The hotter gases are therefore repeatedly separated from the cooler gases and are dashed against the heat-absorbing surfaces, brushing away the cooler gases which otherwise would act as insulators to further heat transfer.

A new method of fire travel

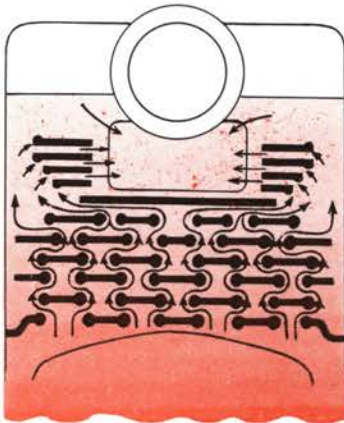

The illustration at the left graphically describes the gas travel between any two intermediate sections of the "O" Series Oil Burning Boiler. The many thin, turbulent streams of gases pursue tortuous paths over a large area of efficient ribbed and prime heat-absorbing surfaces.

A new internal water circulation

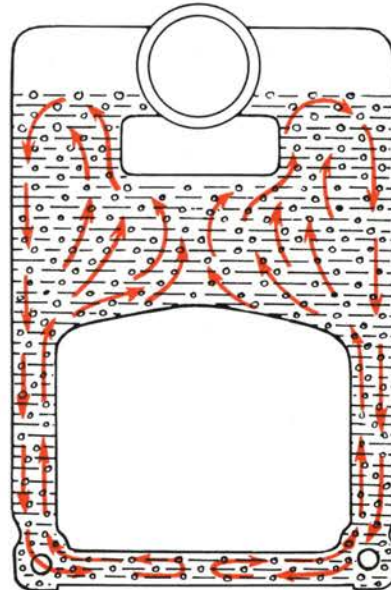

Water circulation within the Capitol Oil Burning Boiler is positive and unrestricted. Definite up and down currents are established which make for complete separation of steam and water. The illustration at the left shows the large, unrestricted areas through which the water circulates.

A new type wet base

The boiler water is carried beneath the combustion chamber and utilizes the heat radiated downward by the burner flame to generate steam.

Quick steaming

The illustration at the right shows that the design embodies a relatively thin water core inside the heat-absorbing surfaces which widens at the water line into one of considerable area.

The small water content achieves quick steaming and a constant, positive wiping action on the inside of the boiler walls which removes steam bubbles as fast as they are formed. The large area of steam-liberating surface at the water line, permits unrestricted separation of steam and water and achieves a steady boiler water line.

As the gases pass through the many passages, constantly releasing their heat, their volume decreases. To compensate for this shrinkage in volume so that the proper velocity of the gases is maintained, the area of the gas passages is decreased in proper proportion to the volume of gases passing through them.

Note the illustration at the right which shows the gas passages formed by the ribbed extensions of adjacent sections.

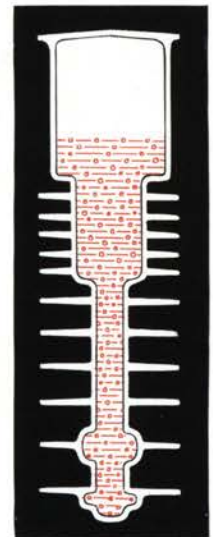
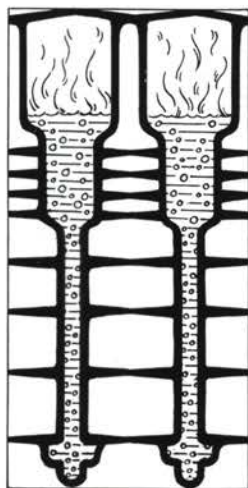

Beauty and Convenience

BEAUTY •

Never before has a Capitol Boiler been tailored with a jacket of such striking beauty. Modern in design, finished in jet black and lustrous green, the jacket is built strong and sturdy.

Thoroughly insulated.—Rock Wool Insulation, which has featured all jacketed Capitol Boilers, is used on the top, sides, front and back.

YEAR-'ROUND HOT WATER •

A large copper domestic hot water heating coil is built into the Capitol Oil Burning Boiler. Through the controls, abundant quantities of hot water are supplied in summer as well as in winter. Careful designing, such as the proper proportioning and location of the extra large upper nipple port of the boiler assure the complete internal water circulation necessary for full capacity in summer operation.

ARRANGED FOR WHOLLY AUTOMATIC OPERATION •

The Capitol Oil Burning Boiler is designed for a complete cycle of automatic operation. These services are possible through the use of standard controls of recognized merit.

Special provision has been made in the construction of the boiler for their easy and effective installation.

The controls provided for are a Stack Switch or Protectorelay, Aquastat, Pressurestat and Low Water Cut-Off, with or without Water Feeder.

A NEW COMPACTNESS IN SIZE •

The design of the "O" Series Capitol Oil Burning Boiler achieves large boiler heating capacity with moderate over-all dimensions. The low water line found on the Capitol Oil Burning Boiler will be of especial advantage in basements of limited head-room.

FRONT OR REAR FIRING •

The Capitol Boiler is designed for firing from either the front or rear of the boiler.

A NEW LOW DRAFT LOSS

The curve tells its own story of low draft loss, a remarkable performance made possible by the boiler design.

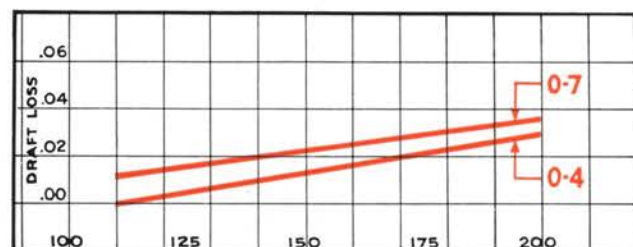
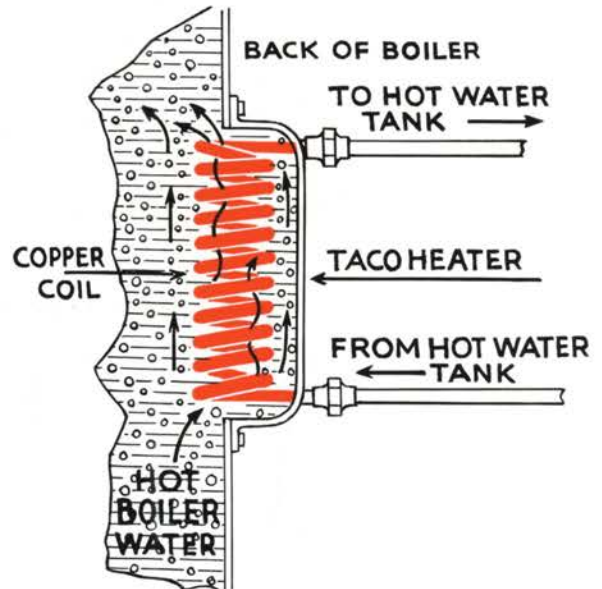

OUTPUT % OF RATED DIRECT CAST IRON RADIATOR LOAD.
CURVE BASED ON 12.5% CO₂.

PERFORMANCE CURVES

"O" SERIES

EFFICIENCY

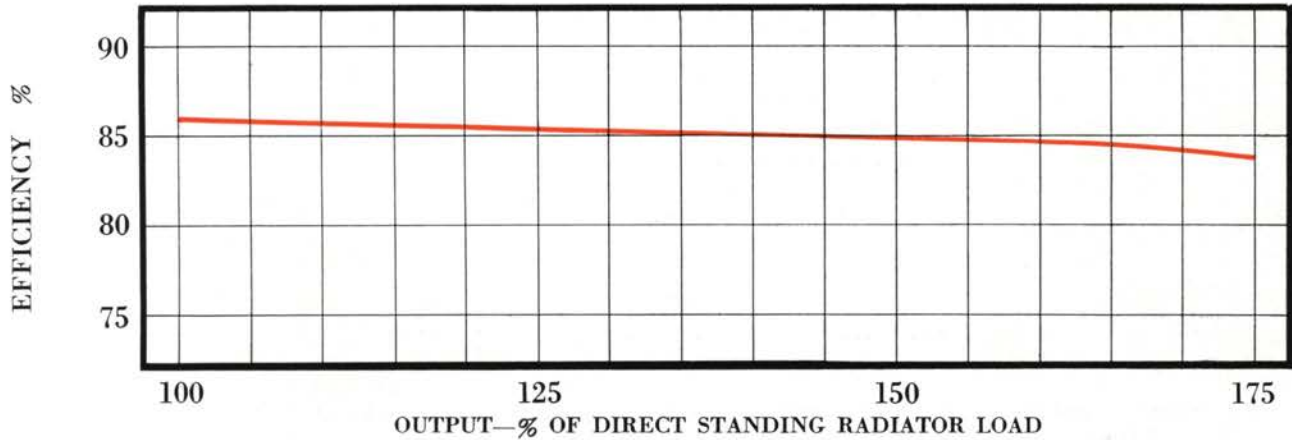

FLUE GAS ANALYSIS:

CO₂—12.5%

O₂—4.1%

CO—0.0%

SMOKEHOOD TEMPERATURE

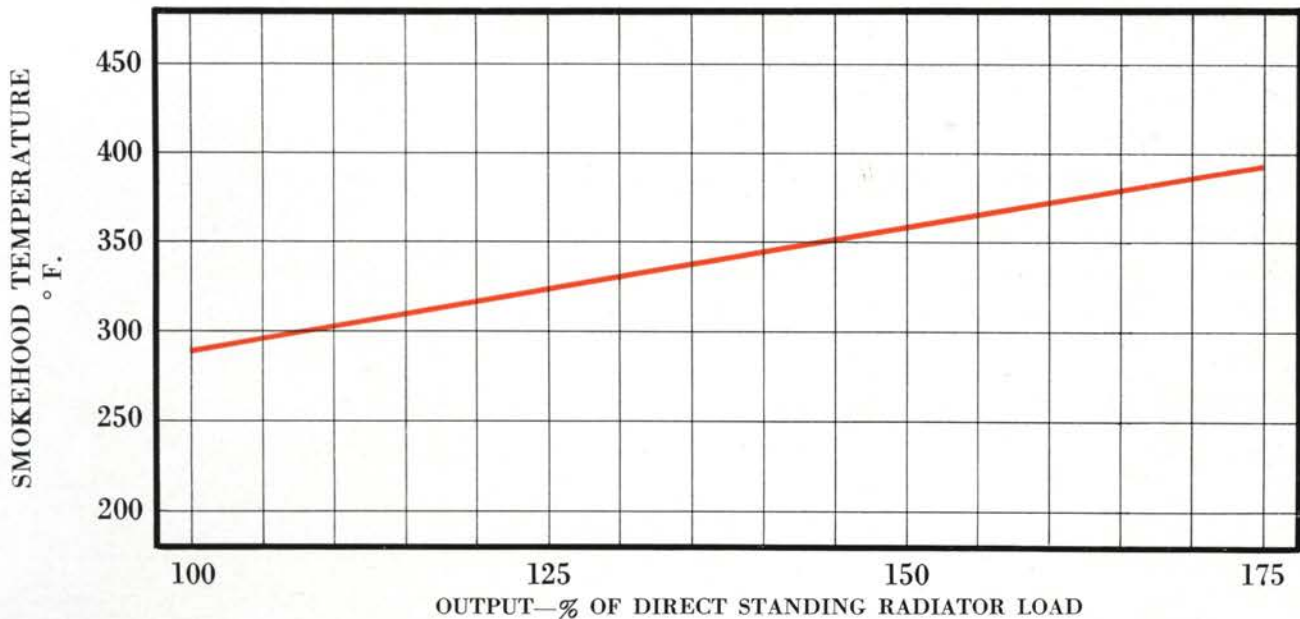

The above curves represent the results secured from a complete series of test runs with a number of the better known, more widely distributed, horizontally fired oil burners.

RATINGS and DATA

① RATINGS	O-3	O-4	O-5	O-6	O-7
Recommended Boiler Output—Steam, Sq. Ft.....	780	1095	1405	1720	2030
—Water, Sq. Ft.....	1250	1750	2250	2750	3250
—B.T.U.....	187,500	262,500	337,500	412,500	487,500
Recommended Standing Radiator Load—Steam, Sq. Ft....	500	700	900	1100	1300
(Without Coil) —Water, Sq. Ft.....	800	1120	1440	1760	2080
Recommended Standing Radiator Load—Steam, Sq. Ft....	425	625	825	1025	1225
(With 100-Gal. Coil) —Water, Sq. Ft.....	680	1000	1320	1640	1960
② Water Heating Capacity of Built-in Coil, Gals.....	100	100	100	100	100
③ Oil Input B.T.U.....	234,000	328,000	422,000	516,000	609,000
③ Oil Input Gals. per hr. No. 3 Oil (7.3 lbs. per gal—19,300 B.T.U. per lb.).....	1.66	2.33	3.00	3.66	4.33
Heating Surface, Total Sq. Ft.....	52.3	74.8	97.3	119.8	142.3
Transmission Rate at recommended boiler output, B.T.U. per sq. ft. of heating surface.....	3590	3510	3470	3440	3420
Chimney, Flue Size, In., and Height, Ft.....	8x12x30	8x12x30	8x12x35	12x12x35	12x12x40
GENERAL DATA:					
Combustion Space (Without refractory lining) Cu. Ft.....	4.2	6.3	8.5	10.6	12.8
Firebox Dimensions, In.....	23x15 ³ / ₈	23x23 ³ / ₈	23x31 ³ / ₈	23x39 ³ / ₈	23x47 ³ / ₈
④ Boiler Outlets—No. and Size.....	1-4"; 1-2"	2-4"	2-4"	2-4"	2-4"
Boiler Inlets—No. and Size.....	2-4"	2-4"	2-4"	2-4"	2-4"

- ① All ratings expressed in sq. ft. are based on a heat emission of 240 B.T.U. per sq. ft. for steam and 150 B.T.U. per sq. ft. for hot water.
- ② All domestic water heater ratings are based on 50°—150° F. in three hours at a minimum boiler water temperature of 180° F. A 150-gal. built-in coil will be supplied on special order at an additional cost. Deduct 112 sq. ft. (steam) or 180 sq. ft. (water) from the "Recommended Standing Radiator Loads without coil" to obtain the recommended standing radiator load when using the 150-gal. coil. Where built-in domestic water heater is not ordered, the opening in the boiler is covered with a plate having a

2" tapping for the upper connection to an externally connected water heater. For each gal. of indirect water heater capacity deduct 0.75 sq. ft. (steam) or 1.2 sq. ft. (water) from the "Recommended Standing Radiator Load without coil".

- ③ Oil input is based on 80 per cent over-all efficiency to allow for those burners which are operated at combustion efficiencies slightly lower than those obtainable with an accurately set burner.
- ④ 2" safety valve tapping on face of back section (50³/₄" from floor) can be used as an outlet on water boilers.

DIMENSIONS

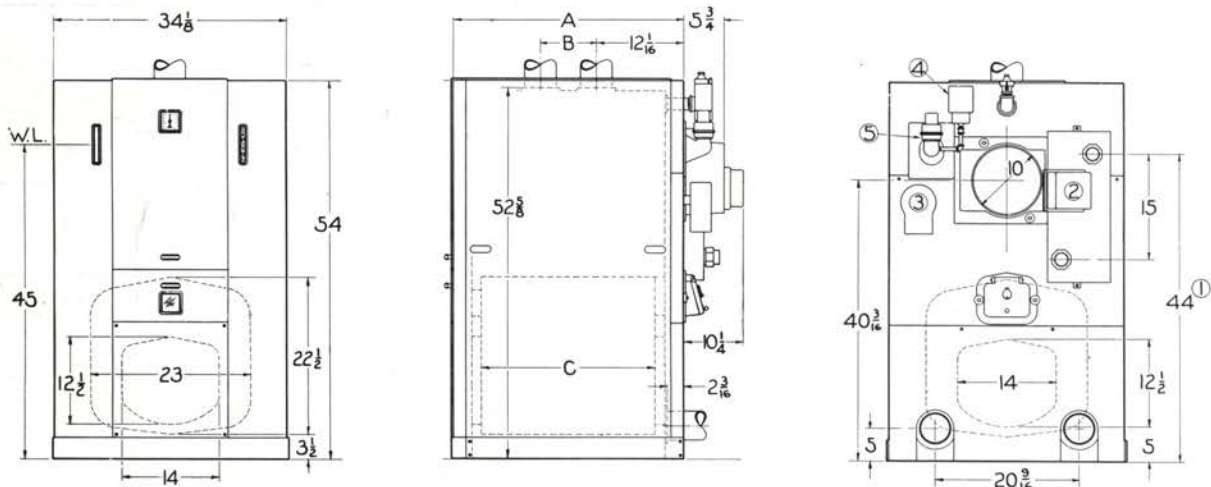

No. of Sections	3	4	5	6	7
A	25"	33"	41"	49"	57"
B	0"	8"	16"	24"	32"
C	15 ³ / ₈ "	23 ³ / ₈ "	31 ³ / ₈ "	39 ³ / ₈ "	47 ³ / ₈ "

- ① When external domestic water heater is used a 2" tapping is furnished 42¹/₂" from floor on cover plate which replaces built-in water heater shown. Stack Switch ②, Aquastat ③ and Pressurestat ④ (not furnished) shown on dimensional drawings for location only.

On water boiler a second Aquastat may be connected to tapping on cover plate which replaces low water cut-off ⑤.

Capitol

"OB"
SERIES
BEAUTY
SIMPLICITY
MODERN DESIGN



Oil Burning Boilers

A Cast Iron Boiler Designed for Oil

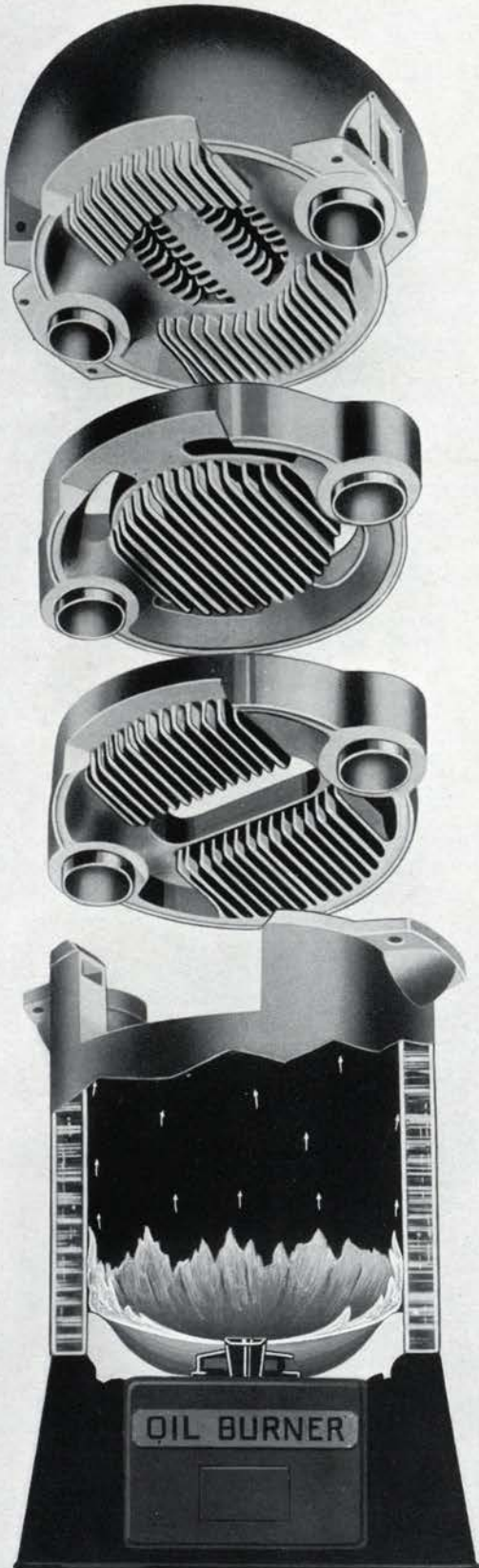

Cast Iron Construction

Efficient oil burning boilers can be manufactured through the use of cast iron. Engineers are not limited in design because cast iron can be molded into the most effective kind of heat-absorbing surfaces.

Efficient Gas Travel

At the left is pictured the gas travel and heating surfaces of the Capitol Oil Burning Boiler. The high efficiencies which are attained in the boiler are due to the fact that the hot gases are compelled to be in direct contact with the heat-absorbing surfaces at all times.

Seven times the direction of the hot gases is changed as they flow through the boiler. With every change of direction, new and hotter gases are impinged upon the heating surfaces.

Arranged for Wholly Automatic Operation

The Capitol Oil Burning Boiler is designed for a complete cycle of automatic operation. These services are possible through the use of standard controls of recognized merit.

Special provision has been made in the construction of the boiler for their easy and effective installation.

Year-'Round Hot Water

Automatically, it will supply clean domestic hot water in abundant quantities all the year around.

Thoroughly Insulated

The Capitol Oil Burning Boiler has a heavy gauge, well-reinforced metal jacket, thoroughly insulated, front, back, sides and top.

UNITED STATES RADIATOR CORPORATION
DETROIT, MICHIGAN

A Product of Unit Engineering

The Capitol OB Series Boiler is designed for economical operation with the burner of your choice.

The many tests made in combination with the better oil burners insure satisfaction.

Note the illustration at the right which shows how the gases are forced into intimate contact with the heat-absorbing surfaces. As the gases rise from the combustion chamber their path through the many small passages is so controlled as to cause them to travel spirally between each projecting rib. Thus the hottest gases are in constant contact with heat-absorbing surfaces and stratification is not possible.

The performance curves shown below are ample proof of the efficiency of this design.

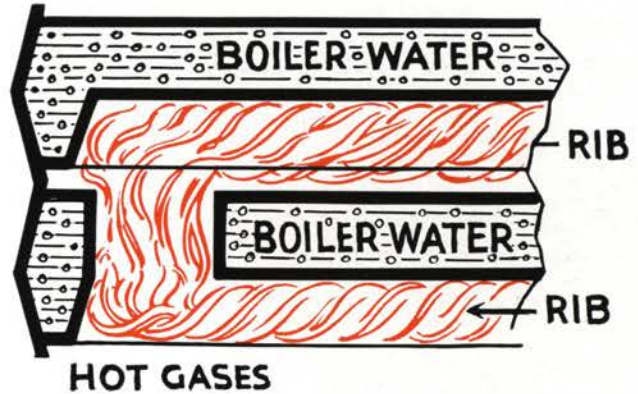

PERFORMANCE CURVES

"OB" SERIES

EFFICIENCY

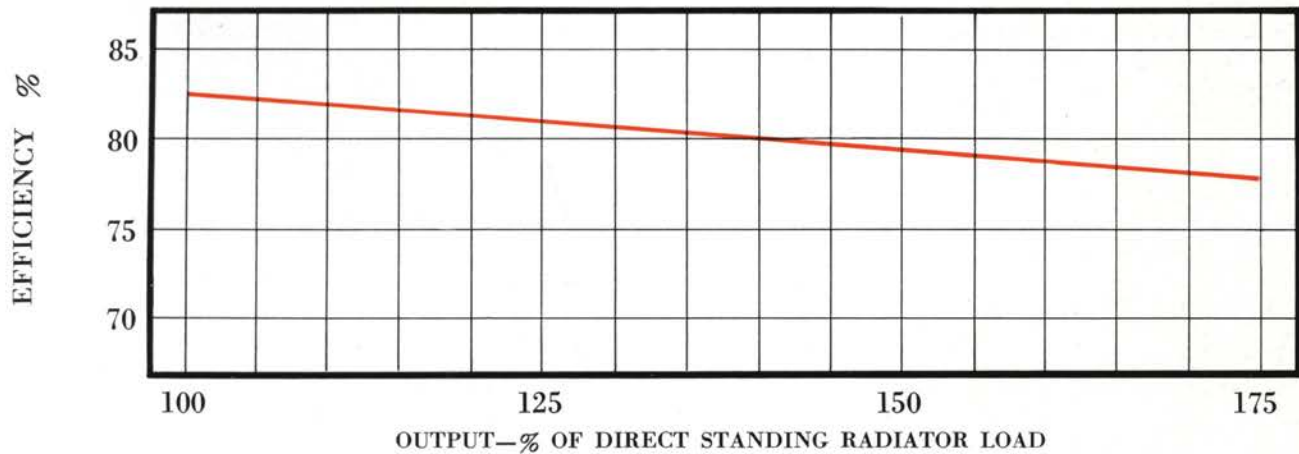

OUTPUT—% OF DIRECT STANDING RADIATOR LOAD

FLUE GAS ANALYSIS—CO₂—12.3%

O₂— 4.4%

CO— 0.0%

SMOKEHOOD TEMPERATURE

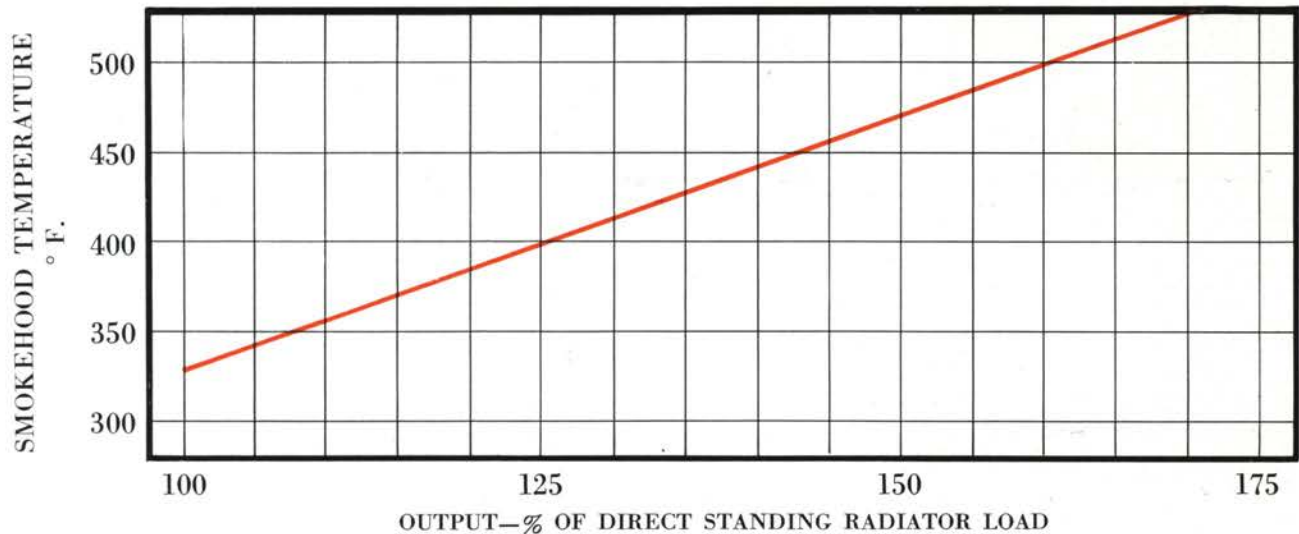

OUTPUT—% OF DIRECT STANDING RADIATOR LOAD

RATINGS and DATA

① RATINGS	OB-20	OB-25
Recommended Boiler Output—Steam, Sq. Ft.....	825	1190
—Water, Sq. Ft.....	1320	1905
—B.T.U.....	198,000	286,000
Recommended Standing Radiator Load—Steam, Sq. Ft.....	530	763
(Without Coil) —Water, Sq. Ft.....	850	1220
Recommended Standing Radiator Load—Steam, Sq. Ft.....	500	700
(With Coil) —Water, Sq. Ft.....	800	1120
② Water Heating Capacity of Built-in Coil, Gals.....	40	85
③ Oil Input, B.T.U.....	264,000	381,000
③ Oil Input, Gals. per hr. (140,000 B.T.U. per gal.).....	1.89	2.72
Heating Surface, Total Sq. Ft.....	38.5	59.9
Chimney, Flue Size, In., and Height, Ft.....	8x12x35	8x12x40
GENERAL DATA:		
Firebox Diameter at base, In.....	19 ³ / ₄	24 ⁷ / ₈
Distance from Floor to Crown Sheet, In.....	31 ³ / ₄	32 ¹ / ₄
Boiler Outlets—No. and Size.....	2-3 ⁷ / ₈	2-3 ¹ / ₂
Boiler Inlets—No. and Size.....	1-3 ¹ / ₂ "	1-4"

- ① All ratings expressed in sq. ft. are based on a heat emission of 240 B.T.U. per sq. ft. for steam and 150 B.T.U. per sq. ft. for water.
- ② All domestic water heater ratings are based on 50°—150° F. in three hours at a minimum boiler water temperature of 180° F. Where built-in domestic water heater is not ordered, the opening in the boiler is covered with a plate having a 1¹/₂" tapping for the upper connection to an externally con-

nected water heater. For each gal. of indirect water heater capacity deduct 0.75 sq. ft. (steam) or 1.2 sq. ft. (water) from the "Recommended Standing Radiator Load without coil."

- ③ Oil input is based on 75 per cent over-all efficiency to allow for those burners which are operated at combustion efficiencies slightly lower than those obtainable with an accurately set burner.

DIMENSIONS

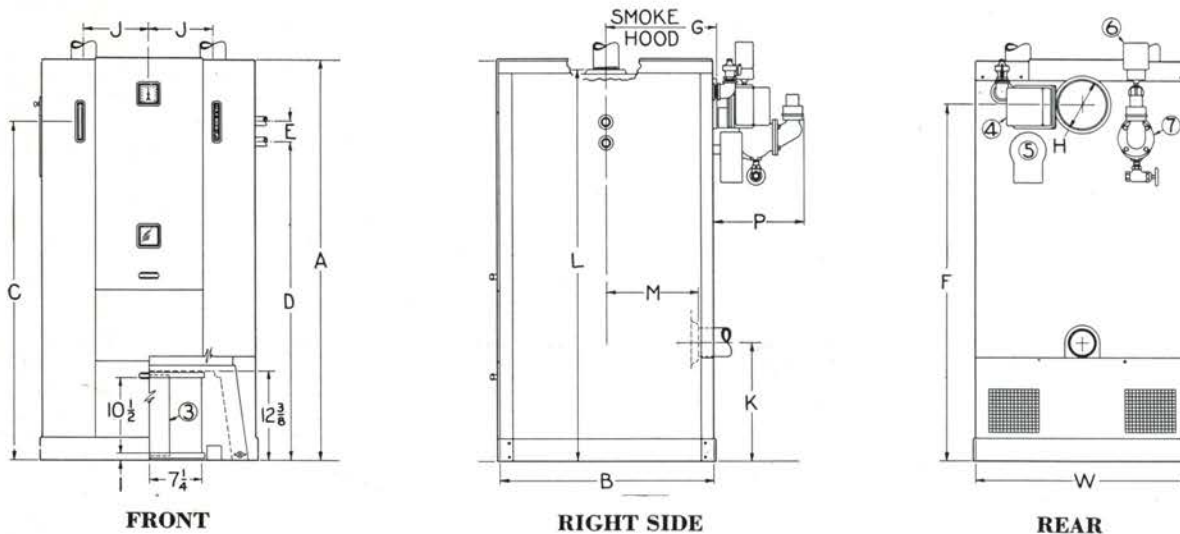

	A	B	C	D	E①	F	G	H	J	K	L	M	W	P②
OB-20.....	56 ¹ / ₂	31 ⁷ / ₈	46 ¹ / ₂	44 ¹ / ₈	2 ⁷ / ₈	49 ⁵ / ₈	15 ³ / ₄	7	8 ¹ / ₈	16 ⁷ / ₈	54 ¹ / ₄	12 ³ / ₄	34	12 ³ / ₄
OB-25.....	57 ³ / ₄	38 ¹ / ₂	47 ⁵ / ₈	44 ¹ / ₄	4	50 ¹ / ₁₆	19 ¹ / ₁₆	8	11 ¹ / ₂	16 ⁷ / ₈	56	15 ³ / ₈	33 ³ / ₄	12 ³ / ₄

- ① Built-in water heater connections. When external domestic water heater is used a 1¹/₂" tapping is furnished on cover plate which replaces built-in water heater.
- ② Dimensions given are for automatic low water cut-off⑦. When water feeder in combination with low water cut-off is used add 2¹/₄".
- ③ Base adjustable air control door is reversible for installation of oil burner at front or rear.

Stack Switch ④, Aquastat ⑤ and Pressurestat ⑥ (not furnished) shown on dimensional drawings for location only.



Capitol Round Boilers

Capitol Round Boilers



Dome Showing Cross Waterway

THE numerous distinctive features of merit found in Capitol Round Boilers are the result of many years of testing and observation as well as experience in the design and manufacture of cast iron heating boilers.

Contributing factors to the remarkable ease of operation and efficiency of performance are the spacious ash-pit, the large tight-fitting doors, the smooth surface of the deep firepot, the sturdy grates, the skillful provisions to insure positive circulation, the synchronous regulation, the staggered fire-travel and the ideal proportion of grate area to heating surface.

The base provides ample capacity for ashes, thus reducing to a minimum the danger of burning out grates. The large base door allows the ashes to be removed very readily.

The firepot is unusually deep, providing ample combustion space above the surface of the fuel bed. The walls of the firepot are smooth and slightly tapered to insure a clean heat-absorbing surface. A clinker door of sufficient size is provided at the base of the firepot for the removal of clinkers and cleaning of the fire. The feed door is exceptionally large. No special shovel is required to fire a Capitol Round Boiler.



Center Hole Section

An ingenious secondary air vent is located in the fire door, which can be made air-tight when desired. Auxiliary air admitted through this vent is passed down between the door and the hot baffle plate, preheated and distributed evenly over the entire surface of the fire. This supply of hot oxygen mixes thoroughly with the volatile gases given off from the fuel, aiding materially in smokeless combustion when burning bituminous fuel and resulting in complete combustion when burning anthracite coal.

Ample facilities for cleaning are provided by the large cleanout doors which give access to the horizontal flues between sections. The smokehood and vertical flue in the dome can be cleaned through a smokehood cleanout door.



Outer Hole Section

One of the factors accounting for the higher efficiency of the Capitol is the staggered flue, which insures a long fire-travel before the hot gases leave the boiler. The flue areas are correctly proportioned to extract the maximum of heat from the products of combustion with a minimum of chimney requirements.

Positive circulation within a boiler is of paramount importance. This matter was given careful consideration in the design of the Capitol Round Boiler. Extra large cast iron push nipples, accurately machined and gauged are used between sections. To insure positive circulation, baffles are cast integral with the sections.



Base Showing Flat Rocking Grates



Typical Water Boiler

An essential feature of a steam boiler is that dry steam be delivered to the radiators. The ideal location of a cross waterway in the steam dome not only insures the extraction of additional heat from the gases leaving the boiler but also acts as a direct feed to the outlet from the back of the steam dome where the steam is exceptionally dry. The position of the steam outlet is an additional safeguard to the delivery of dry steam to the radiators.

In the water dome a cross waterway is also incorporated and the outlets are located directly over the nipple ports, thus contributing to the delivery of hot water with a minimum of resistance.

The draft regulation on all Capitol Round Boilers is accomplished without the use of objectionable pulleys. The regulator rod is directly connected to the check door in the smokehood and the draft door in the base. These doors are suspended on pivot point set-screws, thus reducing friction of movement to a minimum. The slightest increase or decrease in pressure on the regulator supplied with all steam boilers, actuates the draft mechanism. A practical hand regulator is furnished on all water boilers, thus insuring the control of heat generation at all times.

The flat grates are of sturdy, trussed construction. Their operation is accomplished without back-bending. A positive setting of the shaker catch allows the fire to be gently agitated or completely dumped as desired. The Capitol grates are designed to accommodate wood, coke, anthracite or bituminous coal.

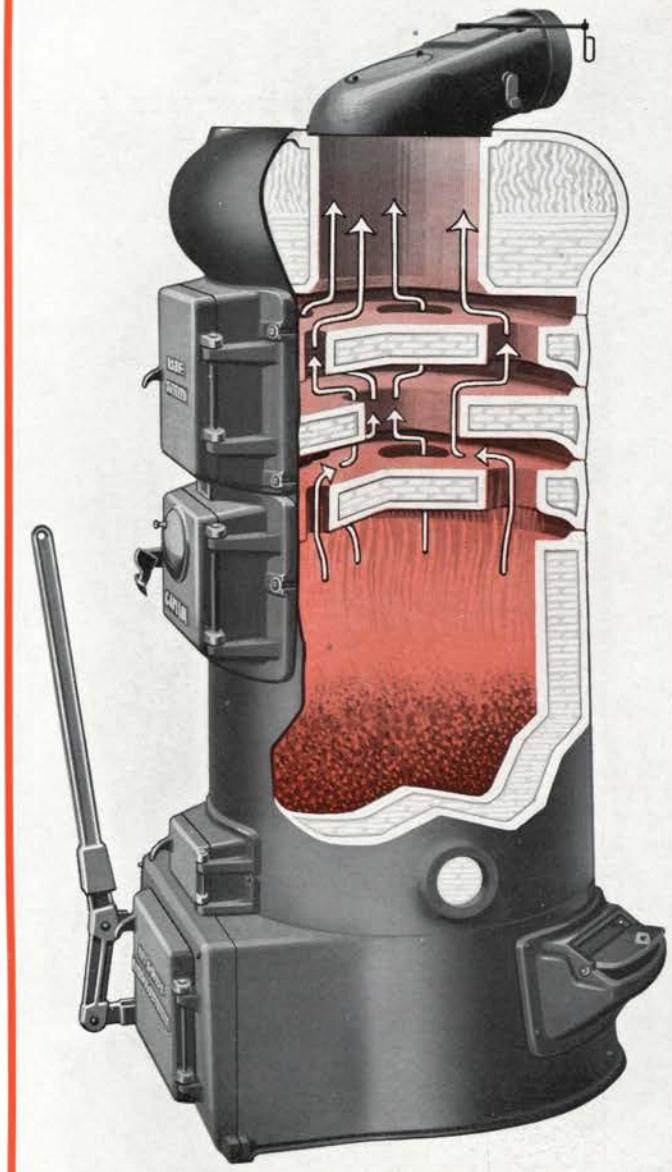

RATINGS and DATA

Boiler No.	FOR ALL FUELS						CHIMNEY DATA		OIL BURNING TYPE					
	Direct Cast Iron Radiator Loads *Sq. Ft.		Water Line In.	Grate Area Sq. Ft.	Hard Coal Fuel Capacity Lbs.	Size of Outlet and Inlet **Inches	Minimum Flue Size Inches	Minimum Chimney Height Feet	Boiler No.	Direct Cast Iron Radiator Loads *Sq. Ft.		Diameter at Hearth	Water Line Inches	Size of Outlet and Inlet **Inches
	Steam	Water								Steam	Water			
17-4	200	330	46 $\frac{7}{8}$	1.44	139	2 $\frac{1}{2}$	8x8	30	017-5	250	415	16	51 $\frac{11}{16}$	2 $\frac{1}{2}$
17-5	250	415	51 $\frac{11}{16}$	1.44	139	2 $\frac{1}{2}$	8x8	30	019-5	350	580	17 $\frac{3}{4}$	51 $\frac{11}{16}$	2 $\frac{1}{2}$
19-4	300	495	46 $\frac{7}{8}$	1.76	170	2 $\frac{1}{2}$	8x12	30	019-6	375	620	17 $\frac{3}{4}$	56 $\frac{1}{2}$	2 $\frac{1}{2}$
19-5	350	580	51 $\frac{11}{16}$	1.76	170	2 $\frac{1}{2}$	8x12	35	020-5	450	745	20	51 $\frac{11}{16}$	3
20-4	400	660	46 $\frac{7}{8}$	2.24	227	3	8x12	30	020-6	475	785	20	56 $\frac{1}{2}$	3
20-5	450	745	51 $\frac{11}{16}$	2.24	227	3	8x12	35	022-5	550	910	22	51 $\frac{11}{16}$	3
20-6	475	785	56 $\frac{1}{2}$	2.24	227	3	8x12	35	022-6	600	990	22	56 $\frac{1}{2}$	3
22-4	500	825	46 $\frac{7}{8}$	2.76	297	3	8x12	35	025-5	675	1115	25 $\frac{5}{16}$	52 $\frac{5}{16}$	3 $\frac{1}{2}$
22-5	550	910	51 $\frac{11}{16}$	2.76	297	3	8x12	35	025-6	725	1195	25 $\frac{5}{16}$	57 $\frac{1}{8}$	3 $\frac{1}{2}$
22-6	600	990	56 $\frac{1}{2}$	2.76	297	3	8x12	40	028-5	850	1405	28 $\frac{5}{16}$	53 $\frac{5}{16}$	4
25-4	625	1030	47 $\frac{1}{2}$	3.54	368	3 $\frac{1}{2}$	8x12	35	028-6	925	1525	28 $\frac{5}{16}$	58 $\frac{1}{8}$	4
25-5	675	1115	52 $\frac{5}{16}$	3.54	368	3 $\frac{1}{2}$	8x12	40						
25-6	725	1195	57 $\frac{1}{8}$	3.54	368	3 $\frac{1}{2}$	8x12	40						
28-4	775	1280	48 $\frac{1}{2}$	4.40	479	4	8x12	35						
28-5	850	1405	53 $\frac{5}{16}$	4.40	479	4	12x12	40						
28-6	925	1525	58 $\frac{1}{8}$	4.40	479	4	12x12	45						

*See Standard Requirements. **Steam boilers have one outlet and two inlets. **Water boilers have two outlets and two inlets. Safety valve sizes accord with A. S. M. E. boiler code. Two 1 $\frac{1}{2}$ " tappings in steam dome for indirect heater and surface blowoff. Two 2" coil openings, 9" centers in firepot for direct heater.

STEAM BOILER EQUIPMENT

Trimming—Regular trimmings include safety valve, steam gauge and regulator.
Firing Tools—Poker and flue scraper. Ash hoe with 25" and 28".
Oil burning boilers not equipped with regulator or poker.

WATER BOILER EQUIPMENT

Firing Tools—Poker and flue scraper. Ash hoe with 25" and 28".

BOILER DIMENSIONS

FOR ALL FUELS STEAM BOILER DIMENSIONS Measurements in Inches

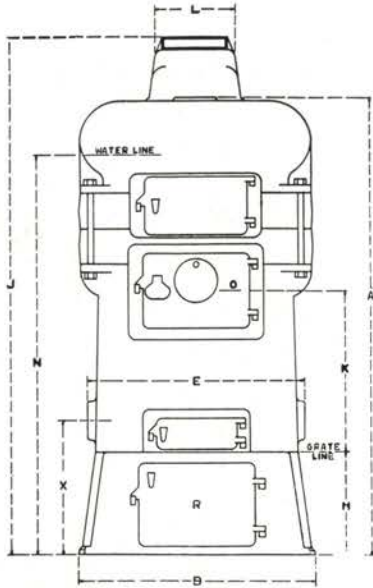

Boiler No.	A	B	E	H	J	K	L	N	O	R	X
17-4	54 1/8	24 3/8	21 3/4	13	61 3/8	21 1/8	8	46 7/8	8 7/8x10 1/4	10x12 1/2	16 1/8
17-5	59 1/8	24 3/8	21 3/4	13	66 1/8	21 1/8	8	51 1/8	8 7/8x10 1/4	10x12 1/2	16 1/8
19-4	54 1/8	26 1/2	23 1/2	13	61 3/8	21 1/8	8	46 7/8	8 7/8x10 1/4	10x14 1/2	16 1/8
19-5	59 1/8	26 1/2	23 1/2	13	66 1/8	21 1/8	8	51 1/8	8 7/8x10 1/4	10x14 1/2	16 1/8
20-4	54 1/8	28 3/8	25 3/4	13	62	21 1/8	9	46 7/8	8 7/8x10 1/4	10x14 1/2	16 1/8
20-5	59 1/8	28 3/8	25 3/4	13	66 3/8	21 1/8	9	51 1/8	8 7/8x10 1/4	10x14 1/2	16 1/8
20-6	64 1/8	28 3/8	25 3/4	13	71 1/8	21 1/8	9	56 1/2	8 7/8x10 1/4	10x14 1/2	16 1/8
22-4	54 1/8	30 1/2	28	13	62	21 1/8	9	47 1/8	9 x13 1/8	10x14 1/2	16 1/8
22-5	59 1/8	30 1/2	28	13	66 3/8	21 1/8	9	51 1/8	9 x13 1/8	10x14 1/2	16 1/8
22-6	64 1/8	30 1/2	28	13	71 1/8	21 1/8	9	56 1/2	9 x13 1/8	10x14 1/2	16 1/8
25-4	56 1/4	33 1/2	31	13	64 1/2	22 1/2	9	47 1/8	9 x13 1/8	10x18	16 3/4
25-5	61 1/4	33 1/2	31	13	68 1/2	22 1/2	9	52 1/8	9 x13 1/8	10x18	16 3/4
25-6	65 1/4	33 1/2	31	13	73 1/2	22 1/2	9	57 1/8	9 x13 1/8	10x18	16 3/4
28-4	57 1/4	36 1/2	34	13	65 1/2	23 1/2	9	48 1/8	9 x13 1/8	10x18	17
28-5	62 1/4	36 1/2	34	13	69 1/2	23 1/2	9	53 1/8	9 x13 1/8	10x18	17
28-6	66 1/4	36 1/2	34	13	74 1/2	23 1/2	9	58 1/8	9 x13 1/8	10x18	17

WATER BOILER DIMENSIONS Measurements in Inches

Boiler No.	A	B	E	H	J	K	L	M	O	R	X
17-4	48 1/8	24 3/8	21 3/4	13	55 1/4	21 1/8	8	17 1/8	8 7/8x10 1/4	10x12 1/2	16 1/8
17-5	52 1/8	24 3/8	21 3/4	13	60 1/4	21 1/8	8	17 1/8	8 7/8x10 1/4	10x12 1/2	16 1/8
19-4	48 1/8	26 1/2	23 1/2	13	55 1/4	21 1/8	8	15 3/8	8 7/8x10 1/4	10x14 1/2	16 1/8
19-5	52 1/8	26 1/2	23 1/2	13	60 1/4	21 1/8	8	15 3/8	8 7/8x10 1/4	10x14 1/2	16 1/8
20-4	48 1/8	28 3/8	25 3/4	13	55 5/8	21 1/8	9	17 7/8	8 7/8x10 1/4	10x14 1/2	16 1/8
20-5	52 1/8	28 3/8	25 3/4	13	60 3/8	21 1/8	9	17 7/8	8 7/8x10 1/4	10x14 1/2	16 1/8
20-6	57 1/4	28 3/8	25 3/4	13	65 1/8	21 1/8	9	17 7/8	8 7/8x10 1/4	10x14 1/2	16 1/8
22-4	48 1/8	30 1/2	28	13	55 5/8	21 1/8	9	19 3/8	9 x13 1/8	10x14 1/2	16 1/8
22-5	52 1/8	30 1/2	28	13	60 3/8	21 1/8	9	19 3/8	9 x13 1/8	10x14 1/2	16 1/8
22-6	57 1/4	30 1/2	28	13	65 1/8	21 1/8	9	19 3/8	9 x13 1/8	10x14 1/2	16 1/8
25-4	49 3/8	33 1/2	31	13	56 1/2	22 1/2	9	23	9 x13 1/8	10x18	16 3/4
25-5	54 1/8	33 1/2	31	13	61 1/2	22 1/2	9	23	9 x13 1/8	10x18	16 3/4
25-6	58 1/4	33 1/2	31	13	66 1/2	22 1/2	9	23	9 x13 1/8	10x18	16 3/4
28-4	50 3/8	36 1/2	34	13	58 1/2	23 1/2	9	24 1/4	9 x13 1/8	10x18	17
28-5	55 1/8	36 1/2	34	13	62 3/8	23 1/2	9	24 1/4	9 x13 1/8	10x18	17
28-6	59 1/4	36 1/2	34	13	67 3/8	23 1/2	9	24 1/4	9 x13 1/8	10x18	17

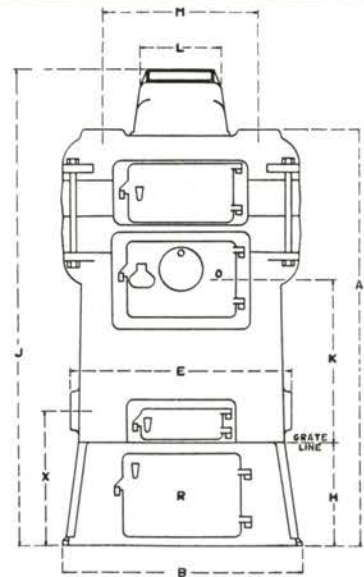

OIL BURNING TYPE

STEAM BOILER MEASUREMENTS—Inches

Boiler No.	A	B	E	H	J	K	L	N	O	R	X
017-5	59 1/8	24 3/8	21 3/4	13	66 1/8	21 1/8	8	51 1/8	8 7/8x10 1/4	11 3/8x12 1/4	16 1/8
019-5	59 1/8	26 1/2	23 1/2	13	66 3/8	21 1/8	8	51 1/8	8 7/8x10 1/4	11 3/8x14 1/2	16 1/8
019-6	64 1/8	26 1/2	23 1/2	13	71 1/8	21 1/8	8	56 1/2	8 7/8x10 1/4	11 3/8x14 1/2	16 1/8
020-5	59 1/8	28 3/8	25 3/4	13	66 3/8	21 1/8	9	51 1/8	8 7/8x10 1/4	11 3/8x14 1/2	16 1/8
020-6	64 1/8	28 3/8	25 3/4	13	71 1/8	21 1/8	9	56 1/2	8 7/8x10 1/4	11 3/8x14 1/2	16 1/8
022-5	59 1/8	30 1/2	28	13	66 3/8	21 1/8	9	51 1/8	9 x13 1/8	11 3/8x17 1/4	16 1/8
022-6	64 1/8	30 1/2	28	13	71 1/8	21 1/8	9	56 1/2	9 x13 1/8	11 3/8x17 1/4	16 1/8
025-5	61 1/8	33 1/2	31	13	68 3/8	22 1/2	9	52 1/8	9 x13 1/8	11 3/8x17 1/4	16 3/4
025-6	65 1/8	33 1/2	31	13	73 3/8	22 1/2	9	57 1/8	9 x13 1/8	11 3/8x17 1/4	16 3/4
028-5	62 1/8	36 1/2	34	13	69 3/8	23 1/2	9	53 1/8	9 x13 1/8	11 3/8x17 1/4	17
028-6	66 1/8	36 1/2	34	13	74 3/8	23 1/2	9	58 1/8	9 x13 1/8	11 3/8x17 1/4	17

WATER BOILER MEASUREMENTS—Inches

Boiler No.	A	B	E	H	J	K	L	M	O	R	X
017-5	52 1/8	24 3/8	21 3/4	13	60 1/4	21 1/8	8	17 1/8	8 7/8x10 1/4	11 3/8x12 1/4	16 1/8
019-5	52 1/8	26 1/2	23 1/2	13	60 1/4	21 1/8	8	15 3/8	8 7/8x10 1/4	11 3/8x14 1/2	16 1/8
019-6	57 1/4	26 1/2	23 1/2	13	65 1/4	21 1/8	8	15 3/8	8 7/8x10 1/4	11 3/8x14 1/2	16 1/8
020-5	52 1/8	28 3/8	25 3/4	13	60 3/8	21 1/8	9	17 7/8	8 7/8x10 1/4	11 3/8x14 1/2	16 1/8
020-6	57 1/4	28 3/8	25 3/4	13	65 3/8	21 1/8	9	17 7/8	8 7/8x10 1/4	11 3/8x14 1/2	16 1/8
022-5	52 1/8	30 1/2	28	13	60 3/8	21 1/8	9	19 3/8	9 x13 1/8	11 3/8x17 1/4	16 1/8
022-6	57 1/4	30 1/2	28	13	65 3/8	21 1/8	9	19 3/8	9 x13 1/8	11 3/8x17 1/4	16 1/8
025-5	54 1/8	33 1/2	31	13	61 3/8	22 1/2	9	23	9 x13 1/8	11 3/8x17 1/4	16 3/4
025-6	58 1/4	33 1/2	31	13	66 3/8	22 1/2	9	23	9 x13 1/8	11 3/8x17 1/4	16 3/4
028-5	55 1/8	36 1/2	34	13	62 3/8	23 1/2	9	24 1/4	9 x13 1/8	11 3/8x17 1/4	17
028-6	59 1/4	36 1/2	34	13	67 3/8	23 1/2	9	24 1/4	9 x13 1/8	11 3/8x17 1/4	17

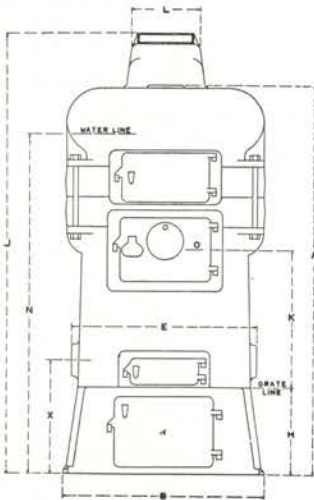

Steam

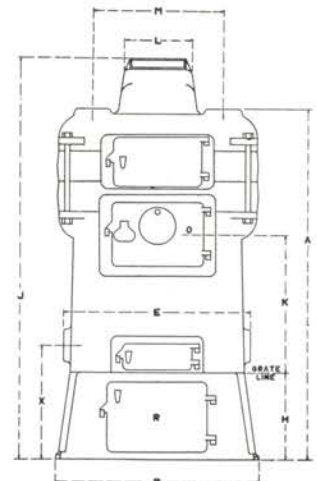

Water



CAPITOL RADIATORS

UNITED STATES RADIATOR CORPORATION
DETROIT, MICHIGAN



Solid Comfort - - -

UPSTAIRS

Capitol Radiators give mellow, glowing warmth where you want it and when you want it.

Homes heated with Capitol Radiators are comfortable, clean and healthful.

The size of the interior, the exposure, the layout of the rooms, the number of stories; none of these affects the warmth and comfort given by Capitol Radiators.

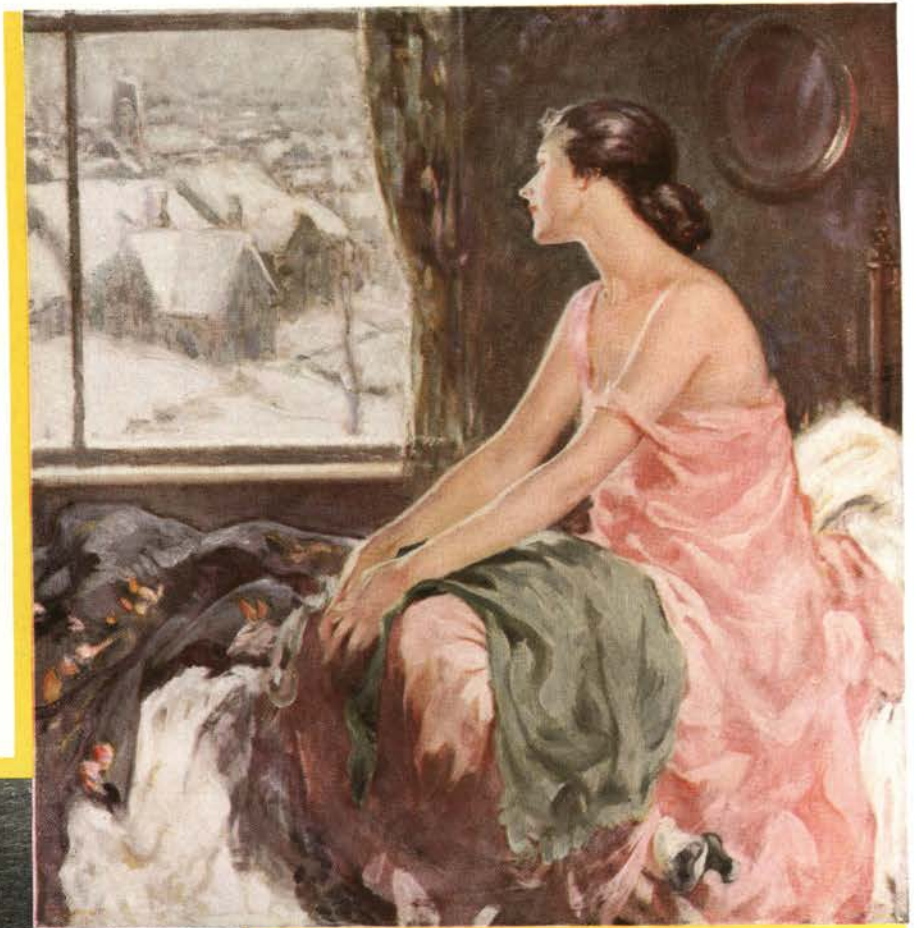

and DOWN

And Capitol Radiators are beautiful, for never has heating efficiency been clothed with greater symmetry.

Every detail aids their capacity, not merely for more speedy transmission of heat but for blending into the decorative scheme of any home.

Capitol Radiators have the added advantage of the most approved type of assembly. Extra heavy malleable iron push nipples, machined with hair-breadth precision, form a perfect, tight, iron-to-iron joint. They need no gaskets, have no threads to rust, are taken apart and assembled with the greatest ease.

CAPITOL THREE TUBE RADIATORS

FOR STEAM OR WATER

No. of Sections	*Length Inches	HEATING SURFACE—SQUARE FEET				
		36-inch Height 3½ Sq. Ft. Per Section	30-inch Height 3 Sq. Ft. Per Section	26-inch Height 2½ Sq. Ft. Per Section	23-inch Height 2 Sq. Ft. Per Section	20-inch Height 1½ Sq. Ft. Per Section
2	5	7	6	4 ² / ₃	4	3 ¹ / ₂
3	7½	10½	9	7	6	5¼
4	10	14	12	9 ¹ / ₃	8	7
5	12½	17½	15	11 ² / ₃	10	8¾
6	15	21	18	14	12	10½
7	17½	24½	21	16 ¹ / ₃	14	12¼
8	20	28	24	18 ² / ₃	16	14
9	22½	31½	27	21	18	15¾
10	25	35	30	23 ¹ / ₃	20	17½
11	27½	38½	33	25 ² / ₃	22	19¼
12	30	42	36	28	24	21
13	32½	45½	39	30 ¹ / ₃	26	22¾
14	35	49	42	32 ² / ₃	28	24½
15	37½	52½	45	35	30	26¼
16	40	56	48	37 ¹ / ₃	32	28
17	42½	59½	51	39 ² / ₃	34	29¾
18	45	63	54	42	36	31½
19	47½	66½	57	44 ¹ / ₃	38	33¼
20	50	70	60	46 ² / ₃	40	35
21	52½	73½	63	49	42	36¾
22	55	77	66	51 ¹ / ₃	44	38½
23	57½	80½	69	53 ² / ₃	46	40¼
24	60	84	72	56	48	42
25	62½	87½	75	58 ¹ / ₃	50	43¾

*Allow ½ inch for each bushing in estimating length of radiators. Tappings 1½ inches, top and bottom, bushed as per list on page 6, unless otherwise specified. Furnished with 6-inch legs on special order, or without legs as illustrated on page 5. Special shapes shown on page 8.

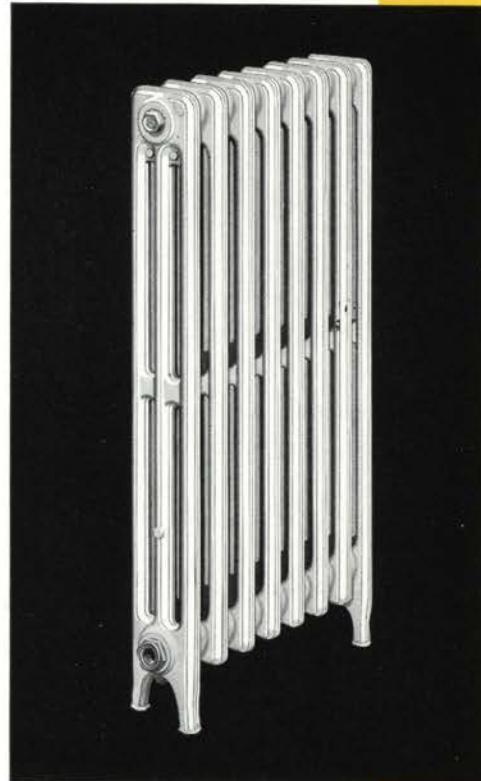

CAPITOL FOUR TUBE RADIATORS

FOR STEAM OR WATER

No. of Sections	*Length Inches	HEATING SURFACE—SQUARE FEET				
		37-inch Height 4¼ Sq. Ft. Per Section	32-inch Height 3½ Sq. Ft. Per Section	26-inch Height 2¼ Sq. Ft. Per Section	23-inch Height 2½ Sq. Ft. Per Section	20-inch Height 2¼ Sq. Ft. Per Section
2	5	8½	7	5½	5	4½
3	7½	12¾	10½	8¼	7½	6¾
4	10	17	14	11	10	9
5	12½	21¼	17½	13¾	12½	11¼
6	15	25½	21	16½	15	13½
7	17½	29¾	24½	19¼	17½	15¾
8	20	34	28	22	20	18
9	22½	38¼	31½	24¾	22½	20¼
10	25	42½	35	27½	25	22½
11	27½	46¾	38½	30¼	27½	24¾
12	30	51	42	33	30	27
13	32½	55¼	45½	35¾	32½	29¼
14	35	59½	49	38½	35	31½
15	37½	63¾	52½	41¼	37½	33¾
16	40	68	56	44	40	36
17	42½	72¼	59½	46¾	42½	38¼
18	45	76½	63	49½	45	40½
19	47½	80¾	66½	52¼	47½	42¾
20	50	85	70	55	50	45
21	52½	89¼	73½	57¾	52½	47¼
22	55	93½	77	60½	55	49½
23	57½	97¾	80½	63¼	57½	51¾
24	60	102	84	66	60	54
25	62½	106¼	87½	68¾	62½	56¼

*Allow ½ inch for each bushing in estimating length of radiators. Tappings 1½ inches, top and bottom, bushed as per list on page 6, unless otherwise specified. Furnished with 6-inch legs on special order, or without legs as illustrated on page 5. Special shapes shown on page 8.



CAPITOL FIVE TUBE RADIATORS

FOR STEAM OR WATER



No. of Sections	*Length Inches	HEATING SURFACE—SQUARE FEET				
		37-inch Height 5 Sq. Ft. Per Section	32-inch Height 4½ Sq. Ft. Per Section	26-inch Height 3½ Sq. Ft. Per Section	23-inch Height 3 Sq. Ft. Per Section	20-inch Height 2½ Sq. Ft. Per Section
2	5	10	8 ² / ₃	7	6	5 ¹ / ₃
3	7½	15	13	10½	9	8
4	10	20	17 ¹ / ₃	14	12	10 ² / ₃
5	12½	25	21 ² / ₃	17½	15	13 ¹ / ₃
6	15	30	26	21	18	16
7	17½	35	30 ¹ / ₃	24½	21	18 ² / ₃
8	20	40	34 ² / ₃	28	24	21 ¹ / ₃
9	22½	45	39	31½	27	24
10	25	50	43 ¹ / ₃	35	30	26 ² / ₃
11	27½	55	47 ² / ₃	38½	33	29 ¹ / ₃
12	30	60	52	42	36	32
13	32½	65	56 ¹ / ₃	45½	39	34 ² / ₃
14	35	70	60 ² / ₃	49	42	37 ¹ / ₃
15	37½	75	65	52½	45	40
16	40	80	69 ¹ / ₃	56	48	42 ² / ₃
17	42½	85	73 ² / ₃	59½	51	45 ¹ / ₃
18	45	90	78	63	54	48
19	47½	95	82 ¹ / ₃	66½	57	50 ² / ₃
20	50	100	86 ² / ₃	70	60	53 ¹ / ₃
21	52½	105	91	73½	63	56
22	55	110	95 ¹ / ₃	77	66	58 ² / ₃
23	57½	115	99 ² / ₃	80½	69	61 ¹ / ₃
24	60	120	104	84	72	64
25	62½	125	108 ¹ / ₃	87½	75	66 ² / ₃

*Allow ½ inch for each bushing in estimating length of radiators. Tappings 1½ inches, top and bottom, bushed as per list on page 6, unless otherwise specified. Furnished with 6-inch legs on special order, or without legs as illustrated on page 5. Special shapes shown on page 8.

CAPITOL SIX TUBE RADIATORS

FOR STEAM OR WATER



No. of Sections	*Length Inches	HEATING SURFACE—SQUARE FEET				
		37-inch Height 6 Sq. Ft. Per Section	32-inch Height 5 Sq. Ft. Per Section	26-inch Height 4 Sq. Ft. Per Section	23-inch Height 3½ Sq. Ft. Per Section	20-inch Height 3 Sq. Ft. Per Section
2	5	12	10	8	7	6
3	7½	18	15	12	10½	9
4	10	24	20	16	14	12
5	12½	30	25	20	17½	15
6	15	36	30	24	21	18
7	17½	42	35	28	24½	21
8	20	48	40	32	28	24
9	22½	54	45	36	31½	27
10	25	60	50	40	35	30
11	27½	66	55	44	38½	33
12	30	72	60	48	42	36
13	32½	78	65	52	45½	39
14	35	84	70	56	49	42
15	37½	90	75	60	52½	45
16	40	96	80	64	56	48
17	42½	102	85	68	59½	51
18	45	108	90	72	63	54
19	47½	114	95	76	66½	57
20	50	120	100	80	70	60
21	52½	126	105	84	73½	63
22	55	132	110	88	77	66
23	57½	138	115	92	80½	69
24	60	144	120	96	84	72
25	62½	150	125	100	87½	75

*Allow ½ inch for each bushing in estimating length of radiators. Tappings 1½ inches, top and bottom, bushed as per list on page 6, unless otherwise specified. Furnished with 6-inch legs on special order, or without legs as illustrated on page 5. Special shapes shown on page 8.

CAPITOL SEVEN TUBE WINDOW RADIATORS

FOR STEAM OR WATER

No. of Sections	*Length Inches	HEATING SURFACE—SQUARE FEET		
		20-inch Height 3 $\frac{3}{8}$ Sq. Ft. Per Section	16 $\frac{1}{2}$ -inch Height 3 Sq. Ft. Per Section	13-inch Height 2 $\frac{1}{2}$ Sq. Ft. Per Section
2	5	7 $\frac{1}{8}$	6	5
3	7 $\frac{1}{2}$	11	9	7 $\frac{1}{2}$
4	10	14 $\frac{2}{3}$	12	10
5	12 $\frac{1}{2}$	18 $\frac{1}{3}$	15	12 $\frac{1}{2}$
6	15	22	18	15
7	17 $\frac{1}{2}$	25 $\frac{2}{3}$	21	17 $\frac{1}{2}$
8	20	29 $\frac{1}{3}$	24	20
9	22 $\frac{1}{2}$	33	27	22 $\frac{1}{2}$
10	25	36 $\frac{2}{3}$	30	25
11	27 $\frac{1}{2}$	40 $\frac{1}{3}$	33	27 $\frac{1}{2}$
12	30	44	36	30
13	32 $\frac{1}{2}$	47 $\frac{2}{3}$	39	32 $\frac{1}{2}$
14	35	51 $\frac{1}{3}$	42	35
15	37 $\frac{1}{2}$	55	45	37 $\frac{1}{2}$

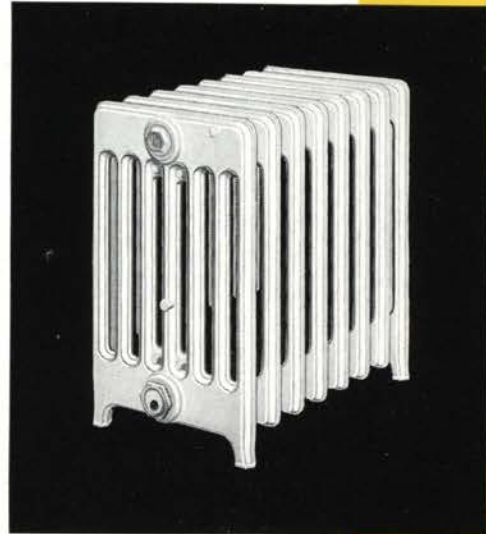

*Allow $\frac{1}{2}$ inch for each bushing in estimating length of radiators. Tappings 1 $\frac{1}{2}$ inches, top and bottom, bushed as per list on page 6, unless otherwise specified. Furnished with 4 $\frac{1}{2}$ -inch legs on special order, or without legs as illustrated on page 5. Special shapes shown on page 8.

CAPITOL WALL HUNG RADIATORS

THE growing demand for wall radiators is given added impetus by the vogue for fully carpeted floors. The housewife objects to cutting expensive carpeting for fitting it around piping. Besides the four tube illustrated, Capitol three, five, six, and seven tube radiators are supplied without legs.

Overall heights of Capitol Radiation with equivalent overall heights for Capitol Wall Hung Radiation appear below.

3, 4, 5 and 6 Tube		7 Tube
37" — 34 $\frac{1}{8}$ "	30" — 27 $\frac{1}{4}$ "	20" — 18 $\frac{3}{8}$ "
36" — 32 $\frac{3}{4}$ "	26" — 23 $\frac{3}{8}$ "	16 $\frac{1}{2}$ " — 15 $\frac{1}{8}$ "
32" — 29 $\frac{1}{8}$ "	23" — 20 $\frac{1}{8}$ "	13" — 11 $\frac{3}{8}$ "
20" — 17 $\frac{5}{8}$ "		

Other dimensions, tappings, etc., are the same as for the regular style.



TRITON BATHROOM WALL RADIATOR

FITS under the lavatory, saving valuable space in modern bathrooms of limited dimensions. Attached with plain lag screws or hooks. Can be supplied in a new enamel finish, as immaculately white as the bathroom fixtures, that will neither chip, check, nor discolor.

Number	Height Inches	Length Inches	Thickness Inches	Nominal Surface Sq. Ft.	Center to Center Bolt Holes Inches
3A	8	16 $\frac{1}{2}$	1 $\frac{1}{2}$	3	11 $\frac{1}{2}$
3 $\frac{1}{2}$ A	8	20 $\frac{1}{2}$	1 $\frac{1}{2}$	3 $\frac{1}{2}$	15 $\frac{1}{2}$

Above radiators tapped $\frac{1}{2}$ inch.

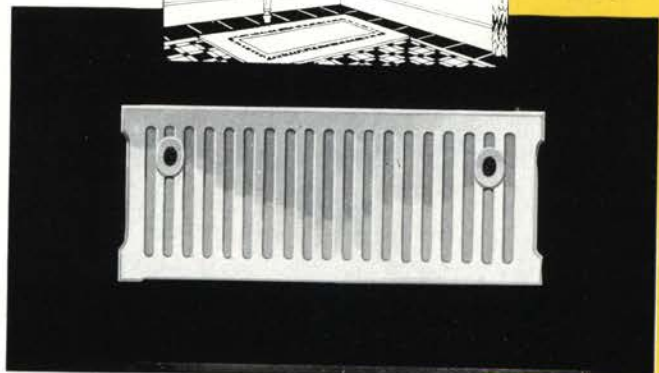
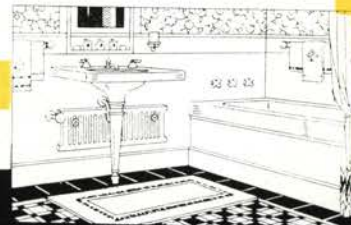

RADIATOR DIMENSIONS

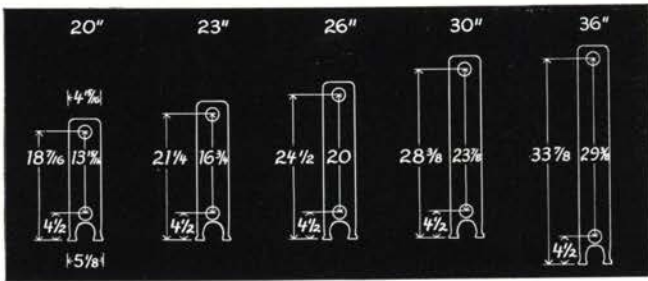

Capitol Three Tube

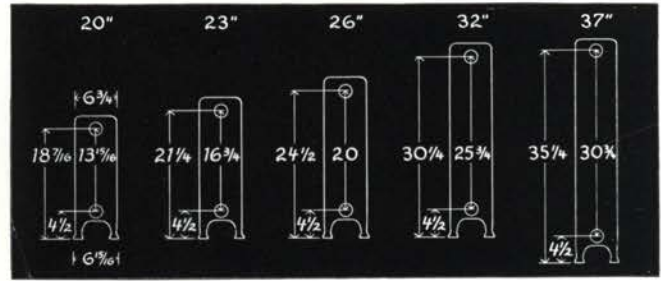

Capitol Four Tube

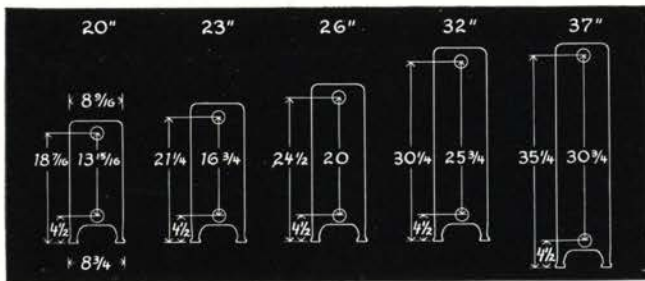

Capitol Five Tube

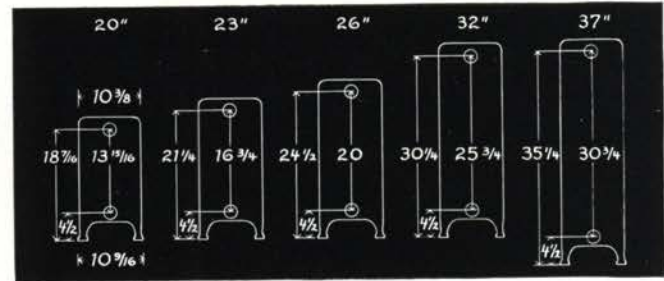

Capitol Six Tube

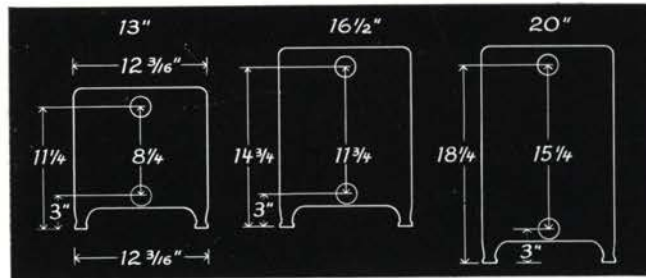

Capitol Seven Tube

RADIATOR TAPPING LIST

ALL Capitol radiators are tapped one and one-half inches at top and bottom, both ends. Tappings are bushed as per list opposite, unless otherwise ordered.

All wall radiators are tapped one and one-half inches.

All Capitol Radiators have right-hand threads at both supply and return, and all Triton Wall Radiators have right-hand threads at one end, and left-hand threads at the other end.

All Air Valve tappings are 1/8 inch. When radiators are ordered for special systems, such as vapor or vacuum, specific instructions should be given as to the method of tapping for supply, return, and vent.

STEAM—ONE-PIPE WORK

Radiators containing 24 square feet and under	1 inch
Above 24, but not exceeding 60 square feet	1 1/4 inch
Above 60 square feet	1 1/2 inch

STEAM—TWO-PIPE WORK

Radiators containing 48 square feet and under	1 x 3/4 inch
Above 48, but not exceeding 96 square feet	1 1/4 x 1 inch
Above 96 square feet	1 1/2 x 1 1/4 inch

WATER

Tapped for Supply and Return

Radiators containing 40 square feet and under	1 inch
Above 40, but not exceeding 72 square feet	1 1/4 inch
Above 72 square feet	1 1/2 inch

CAPITOL HOSPITAL RADIATORS

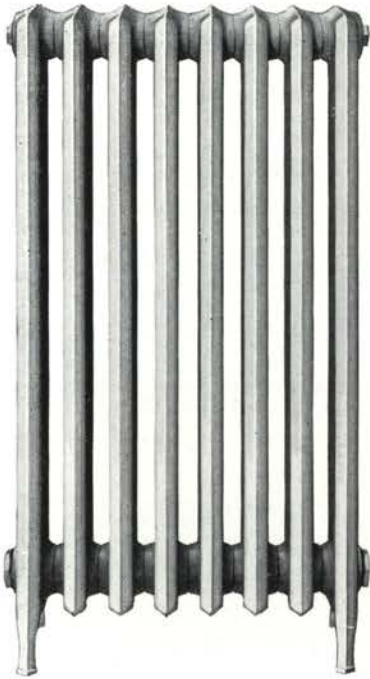

CAPITOL Hospital Radiators are manufactured with extra large spacing between sections in the regular 2½-inch center style. They can also be furnished on special order with 3-inch centers at no extra charge.

The extra spacing between sections allows free access

for thorough cleaning which is so essential for hospital, school and institutional use. Capitol Hospital Radiators are supplied in three and five tube patterns *only*. They are furnished with or without legs.

Dimensions and heating surfaces are the same as the regular styles listed on pages 3 and 4.

RADIATOR LEGS, FEET, AND PEDESTALS

ADJUSTABLE FEET

Consist of two iron blocks that open by turning the top piece which is so cast that any radiator foot will fit securely. Adjustment can be made with the screw, which holds the two pieces in place. They can be used on any kind of fixture that must stand level. Furnished in plain iron and can be bronzed or painted to correspond to fixture upon them.



- No. 1 extends 7/8 to 1¼ inches.
- No. 2 extends 1¼ to 1¾ inches.
- No. 3 extends 1½ to 2½ inches.
- No. 4 extends 2 to 3 inches.
- No. 5 extends 3 to 4 inches.
- No. 6 extends 4 to 5 inches.

CENTER LEGS

For all radiation: No center legs will be assembled in radiators up to and including 25 sections. Radiators from 26 to 49 sections inclusive have one center leg. Radiators from 50 to 73 sections inclusive have two center legs. Beyond 73 sections, three center legs will be used.



PEDESTALS

Solid cast-iron pedestals can be furnished for placing under legs of all styles of our radiators and are made in the following heights: ½, ¾, 1, 1½, 2, 2½, 3, 3½, 4, 4½, 5, 5½, and 6 inches.

CAPITOL CORNER, ANGLE AND CURVED RADIATORS

CORNER RADIATOR

Capitol special patterns include corner, curved, two and three angle radiators. Dimensions are the same as for Capitol regular styles. Capitol circular radiators can be furnished on special order, assembled either in one piece or in halves to be assembled on the job. Half circles may also be ordered for installation as two separate radiators.

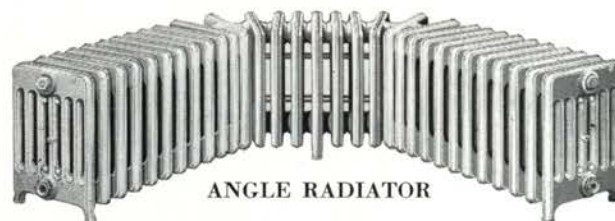

ANGLE RADIATOR

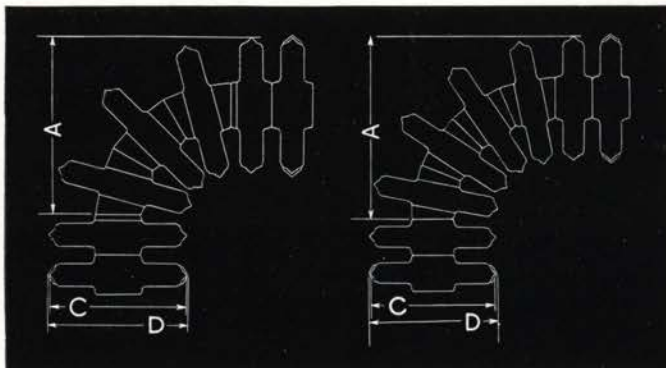

3 Section Corner Radiator Dimensions				4 Section Corner Radiator Dimensions			
Tube	A	C	D	Tube	A	C	D
3 Tube	8 $\frac{1}{8}$	4 $\frac{1}{8}$	5 $\frac{1}{8}$	3 Tube	10 $\frac{3}{8}$	4 $\frac{1}{8}$	5 $\frac{1}{8}$
4 Tube	9 $\frac{1}{8}$	6 $\frac{3}{8}$	6 $\frac{1}{8}$	4 Tube	11 $\frac{1}{8}$	6 $\frac{3}{8}$	6 $\frac{1}{8}$
5 Tube	10 $\frac{1}{8}$	8 $\frac{1}{8}$	8 $\frac{3}{8}$	5 Tube	12 $\frac{1}{8}$	8 $\frac{1}{8}$	8 $\frac{3}{8}$
				6 Tube	14 $\frac{1}{8}$	10 $\frac{3}{8}$	10 $\frac{1}{8}$
				7 Tube	15 $\frac{3}{8}$	12 $\frac{1}{8}$	12 $\frac{1}{8}$

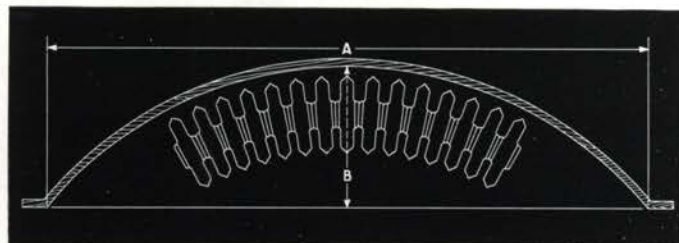

When ordering curved radiators, give measurements A and B

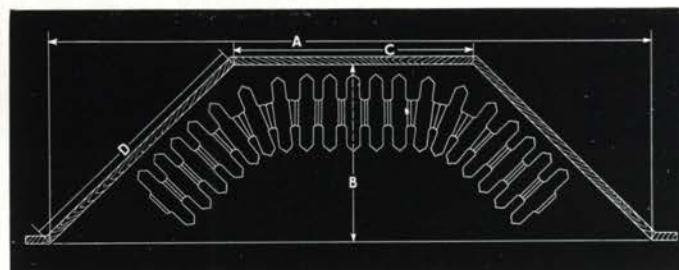

When ordering bay window radiators, give measurements A, B, C and D

CAPITOL DIRECT-INDIRECT BOX BASE

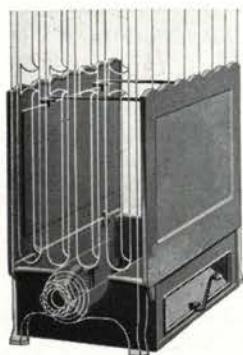

MADE for five tube Capitol radiators. When front damper is opened the back automatically closes, admitting air from the room only. When the back damper is opened the front closes, taking air from outdoors. Can be changed from back inlet to bottom inlet by setting both dampers to operate together. Front and back curtains can be removed for cleaning.

A 15-section Base is used on radiators of 15 sections or odd numbers above 15; and a 14-section Base is used on radiators of 14 sections or even numbers above 14.

When ordering Direct-Indirect radiators, specify sections under which the box base is to be installed, in order that center legs can be arranged accordingly.

2 1/2 inches; size of opening in brick work, 17 1/4 x 5 1/8 inches; size for galvanized iron, 17 x 4 7/8 inches. For application and data see below.

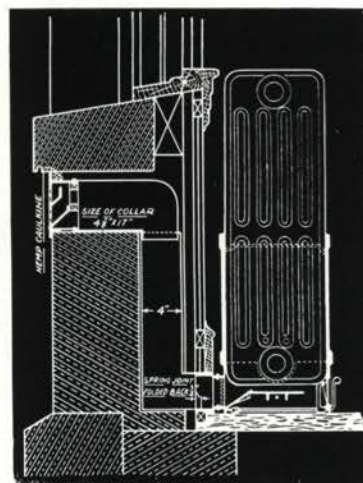

WALL BOXES

Water-tight and durable, with heavy copper screen firmly held in position at back of box, keeping out insects and dirt. The main part of the box is of one piece. From front flange to back of box,

No. of Sections	Back Opening 5 Tube	Maximum Bottom Opening 5 Tube	No. of Sections	Back Opening 5 Tube	Maximum Bottom Opening 5 Tube
5	2 1/2 x 5 1/8	8 x 5 1/2	10	2 1/2 x 17 1/8	8 x 18
6	2 1/2 x 7 1/8	8 x 8	11	2 1/2 x 20 1/8	8 x 20 1/2
7	2 1/2 x 10 1/8	8 x 10 1/2	12	2 1/2 x 22 1/8	8 x 23
8	2 1/2 x 12 1/8	8 x 13	13	2 1/2 x 25 1/8	8 x 25 1/2
9	2 1/2 x 15 1/8	8 x 15 1/2	14	2 1/2 x 27 1/8	8 x 28
			15	2 1/2 x 30 1/8	8 x 30 1/2

Height of back air-inlet above floor 3/8 inches.

TRITON WALL RADIATORS

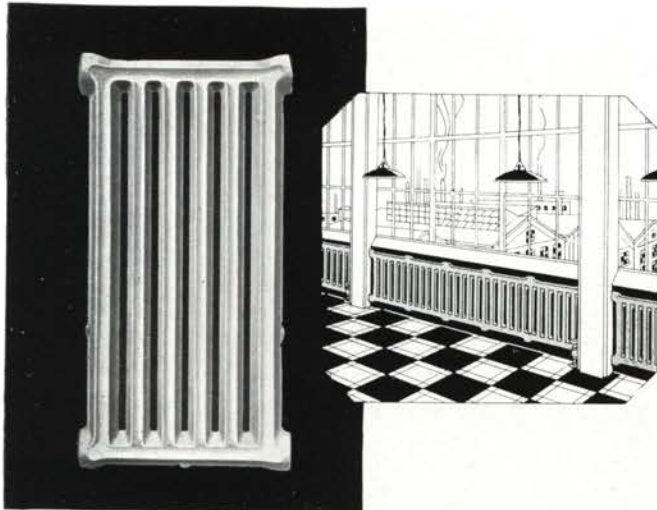

No. 9-B for side to side assembly

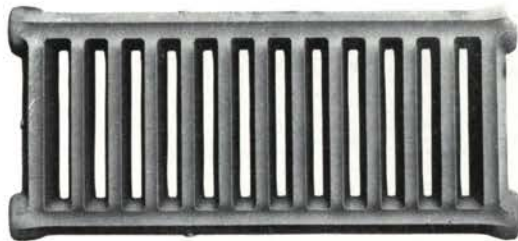

No. 9-A for end to end assembly

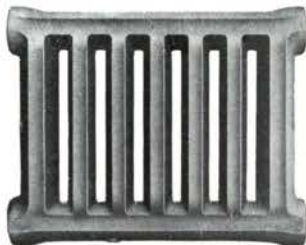

No. 5-A for end to end assembly



No. 7-B for side by side assembly

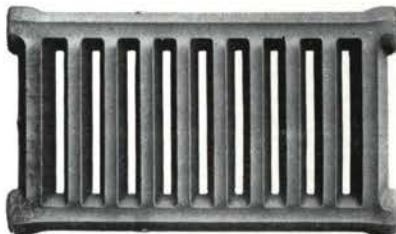

No. 7-A for end to end assembly

Section Numbers	Height Inches	Length or Width Inches	Thickness Inches	Thickness With Brkts. Inches	Heating Surface Sq. Ft.
5A	14 1/8	16 1/2	3	3 1/2	5
7A	14 1/8	22 7/8	3	3 1/2	7
9A	14 1/8	29 1/4	3	3 1/2	9
7B	22 7/8	14 1/2	3	3 1/2	7
9B	29 1/4	14 1/2	3	3 1/2	9

Above radiators are tapped 1 1/2 inches.

FOR factories, storage houses, corridors, stairways, lobbies, and wherever the utmost radiating surface is needed in limited space, Triton Wall Radiators are unexcelled.

The wide variety of sizes adaptable to either tier or stack arrangement permits adapting their installation to any wall space available.

Sections may be added at any time should the building be enlarged. Steam or water may be confined to any number of the units during mild weather, assuring uniform temperatures with maximum economy. Condensed steam or exhaust steam often available in industrial installations may be utilized with the greatest efficiency.

No wall radiators are built that are more efficient, adaptable, or durable.

IN ordering, state the size and number of sections to each radiator, give the assembly figure number and state the number of "Tiers" high or "Stacks" wide, as the case may be. State also the size and location of tappings desired, using the tapping numbers shown on figure for this purpose.

Sections are assembled for shipment only in single tiers or single stacks. Where figures show double tiers or double stacks it is to be understood that the figures will be shipped disconnected at the hexagon nipples. Note that when sections, regardless of type, are assembled side to side, the maximum number of sections which will be shipped assembled is, for each size:—

5 ft.—5 sections	9 ft.—5 sections
7 ft.—5 sections	See Figures 9-11-13-15-2-6

And when assembled end to end the maximum number of sections which will be shipped assembled is, for each size:—

5 ft.—5 sections	9 ft.—3 sections
7 ft.—4 sections	See Figures 1-3-5-7-15-8-10-12

The regular tappings as shown on the various assembly figures are indicated by 2, 3, 4, 5, 6, 7, 8 and 9. 12, 13, 14, 15, 16, 17, 18, 19 indicate special tappings which can be furnished at points so marked if required and for which an extra charge of 10 cents each, net, will be made.

Numbers 2, 9, 3, 4, and 12, 19, 13, 14 are left hand tappings.
Numbers 5, 6, 7, 8, and 15, 16, 17, 18 are right hand tappings.

Tappings are 1 1/2" supply and return and are bushed as per list on page 6.

CRATING

Units of Triton Wall Radiators are crated as follows:

9 FOOT HORIZONTAL—9-A

When assembled as per Figure No. 1—3 sections and over
When assembled as per Figure No. 9—5 sections and over

7 FOOT HORIZONTAL—7-A

When assembled as per Figure No. 1—4 sections and over
When assembled as per Figure No. 9—5 sections and over

7 FOOT VERTICAL—7-B

When assembled as per Figure No. 2—5 sections and over
When assembled as per Figure No. 8—4 sections and over

9 FOOT VERTICAL—9-B

When assembled as per Figure No. 2—5 sections and over
When assembled as per Figure No. 8—3 sections and over

5 FOOT VERTICAL—5-A & 5-B

All assembly of 5 sections and over

WALL RADIATOR ASSEMBLY

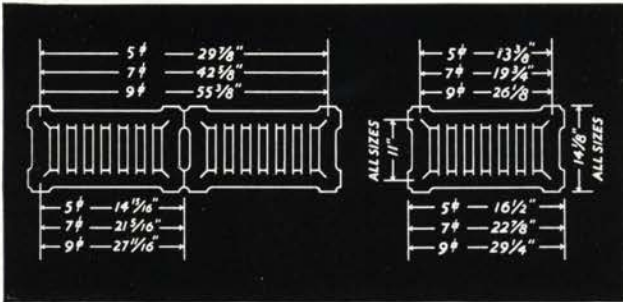

Above measurements apply to A or B styles.

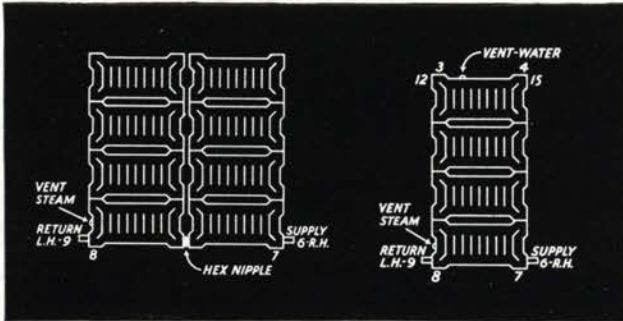

Fig. 13. Assembled in two or more stacks. Fig. 9. Assembled in single stack. One and two pipe steam only. Bottom feed. Water or one and two pipe steam.

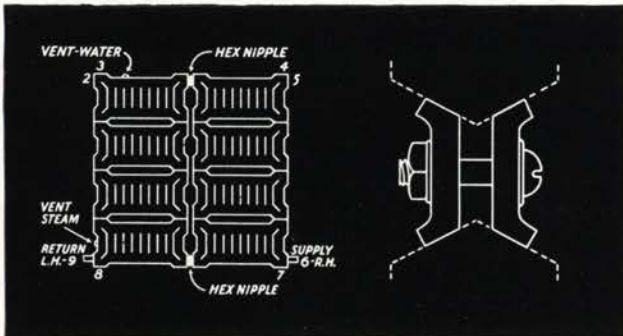
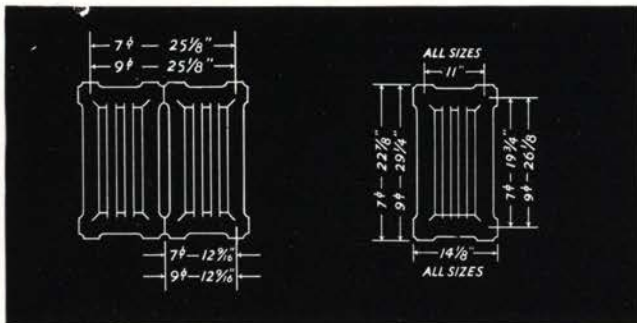

Fig. 11. Assembled in two or more stacks. Water or steam. Adjustable Spacing Saddle. Furnished between sections. See figures 17, 16, and 18 on pages 10 and 11.



Above measurements apply to A or B styles.

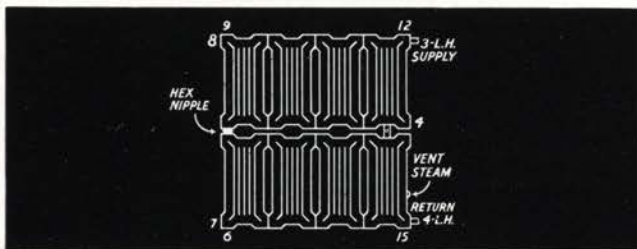

Fig. 16. Assembled in eight sections in two tiers. For two pipe steam using adjustable spacing saddle.



Fig. 1. Assembled in single tier. Water or one and two pipe steam.

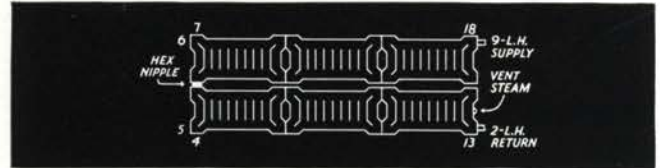

Fig. 7. Assembled in two tiers. Two pipe steam only.

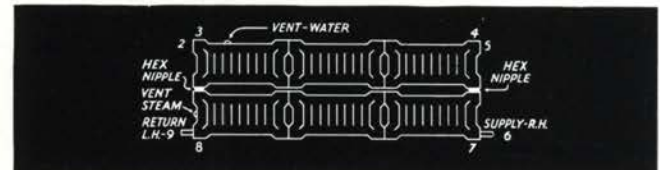

Fig. 3. Assembled in two or more tiers. Water or steam.

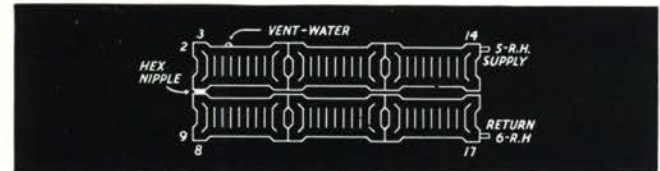

Fig. 5. Assembled in two tiers. Water only.

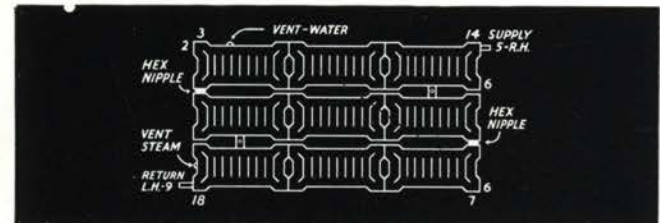

Fig. 17. Assembled nine sections in three tiers. Using adjustable spacing saddle.

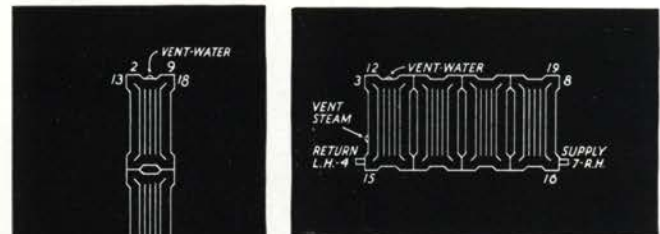

Fig. 2. Assembled in single tier. For water or one and two pipe steam.



Fig. 8. Assembled in single stack. Water or one and two pipe steam.

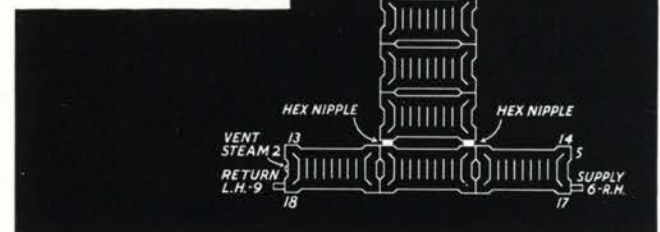

Fig. 15. Assembled in single tier and single stack. Water or one and two pipe steam.

WALL RADIATOR ASSEMBLY

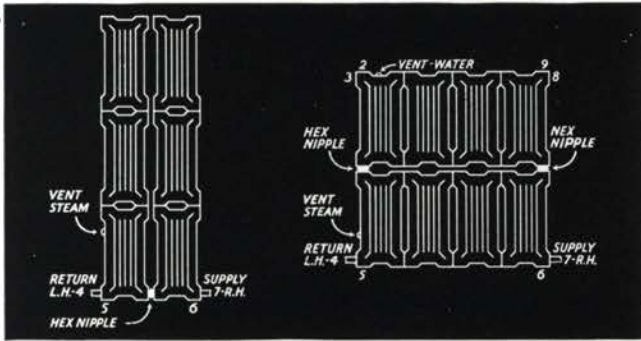

Fig. 12. Assembled in two or more stacks. One and two pipe steam only. Bottom feed. Fig. 6. Assembled in two or more tiers. Water or steam.

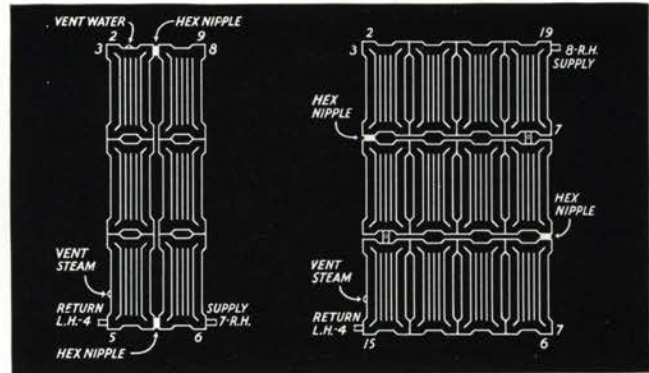
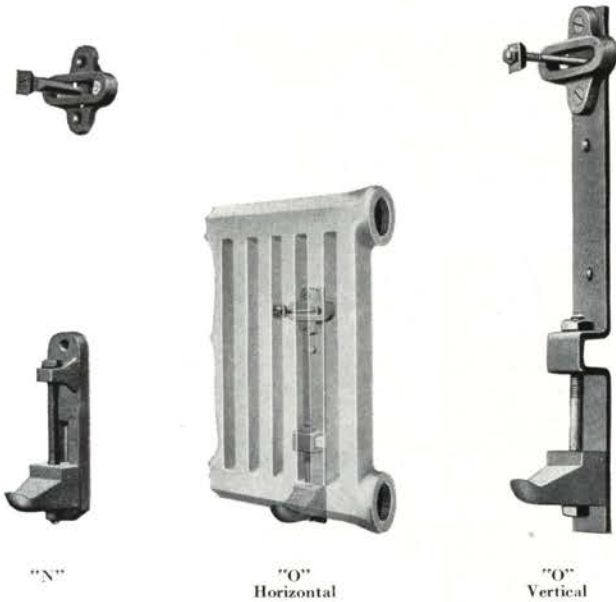

Fig. 10. Assembled in two or more stacks. Water or steam. Fig. 18. Assembled in twelve sections in three tiers. Using adjustable spacing saddle.

TRITON ADJUSTABLE WALL BRACKETS



ADJUSTABLE FOR PITCH AFTER RADIATOR IS ERECTED

Triton Adjustable Brackets are made to support wall radiators in large or small tiers or stacks in buildings of any character where wall radiation is installed.

They are strong and substantial, and hold radiators securely in place. They are adjusted after attachment to walls by a single expansion bolt.

Triton Adjustable Brackets are made in two styles.

"N" Brackets can be screwed to the wall to support any arrangement of wall radiation.

"O" Bracket, with bearing plate, is attached to wall with $\frac{1}{2}$ " Expansion Bolts, materially reducing the cost of construction and guaranteeing a safe and secure attachment.

Vertical movement of the seat of "N" and "O" Bracket is 2", permitting adjustment for pitch after radiators are erected. The brackets set the outer face of the radiator $4\frac{7}{8}$ " from the wall.

Screw sizes suitable for use on "N" Bracket:

Top Bracket—Size of hole, $\frac{1}{4}$ "—Use No. 14 Wood Screw.

Bottom Bracket—Size of hole, $\frac{5}{16}$ "—Use $\frac{1}{2}$ " Lag Screw.

"N" Brackets mounted on steel plates.

Top Bracket, $\frac{3}{8}$ "—Flat Head Machine Screw to fasten to plate.

Bottom Hole, $\frac{5}{16}$ "—For $\frac{1}{2}$ " Lag Screw to wall.

Bottom Bracket, $\frac{3}{8}$ "—Machine Screw to fasten to plate.

Bottom Hole—For $\frac{1}{2}$ " Lag Screw to fasten to wall.

CHART showing by vertical lines, how many and where to place Triton Adjustable Wall Brackets upon radiators of different assemblages.

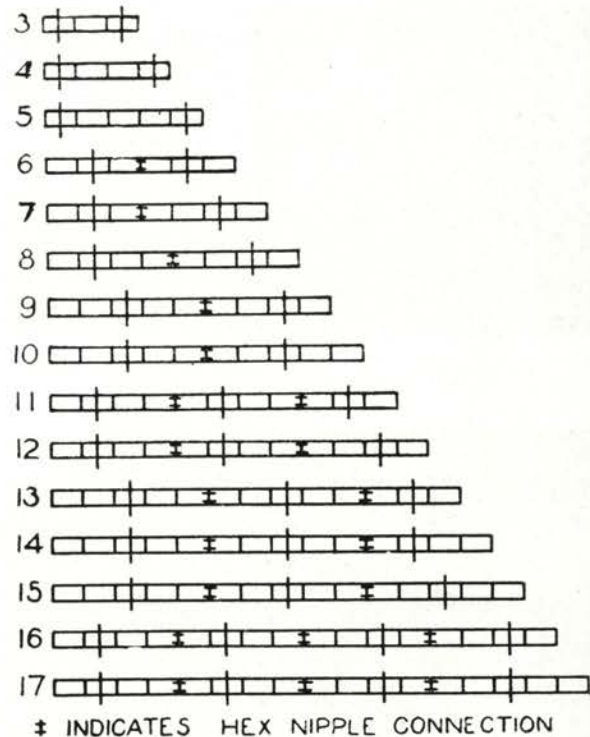

For longer assemblage combine the above figures as follows:

18..... 10+8	24..... 15+9
19..... 10+9	25..... 15+10
20..... 10+10	26..... 12+14
21..... 12+9	27..... 12+15
22..... 12+10	28..... 15+13
23..... 10+13	29..... 15+14
30..... 15+15	

WALL RADIATOR BRACKETS

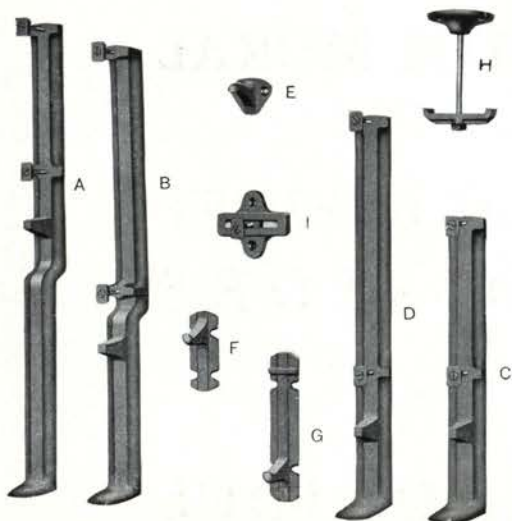

Brackets "B" to fit over a 9½-inch high baseboard for supporting wall radiators Nos. 7-B and 9-B.

HEIGHT FROM FLOOR TO CENTER OF TAPPING

No. B 5½ from floor to center.....	5½"
No. B 7½ from floor to center.....	7½"
No. B 9½ from floor to center.....	9½"

Brackets "D" are straight right angle brackets without offset for supporting Nos. 7-B and 9-B. Distance from floor to center of tapping, 5½ inches.
Brackets "A" to fit over baseboard for supporting Nos. 5A, 7A and 9A.

HEIGHT FROM FLOOR TO CENTER OF TAPPING

No. A 6 will fit over baseboard.....	1½"	6"
No. A 8 will fit over baseboard.....	3½"	8"
No. A 10 will fit over baseboard.....	5½"	10"
No. A 12 will fit over baseboard.....	7½"	12"
No. A 14 will fit over baseboard.....	9½"	14"
No. A 16 will fit over baseboard.....	11½"	16"

Brackets "C" are straight right angle brackets without offset, for supporting Nos. 5A, 7A and 9A. Distance from floor to center of tapping, 5½ inches.

Brackets "F," "G," "E," and "I" are screwed to wall, baseboard and wainscoting. "F" and "G" are bottom supports for all sizes; "E" and "I" top guides to hold radiator in place should always be used with "F" and "G" brackets. "F" and "G" brackets are slotted for four wood screws not furnished by us, and "E" and "I" are for two wood screws.

Ceiling brackets "H" for supporting radiator from ceilings, made of cast plate 3½ inches in diameter to be screwed to ceiling joist by four screws. Bolt furnished gives a distance from 3½ to 5 inches from bottom of radiator to ceiling. Other lengths on special order.

With brackets "A," "B," "D," and "C" we furnish two ¼ x 2½ F. H. stove bolts with button, and with bracket "I" one 2¼ stove bolt with button.

TU-BU-LUR RADIATOR HANGER FOR CAPITOL RADIATORS

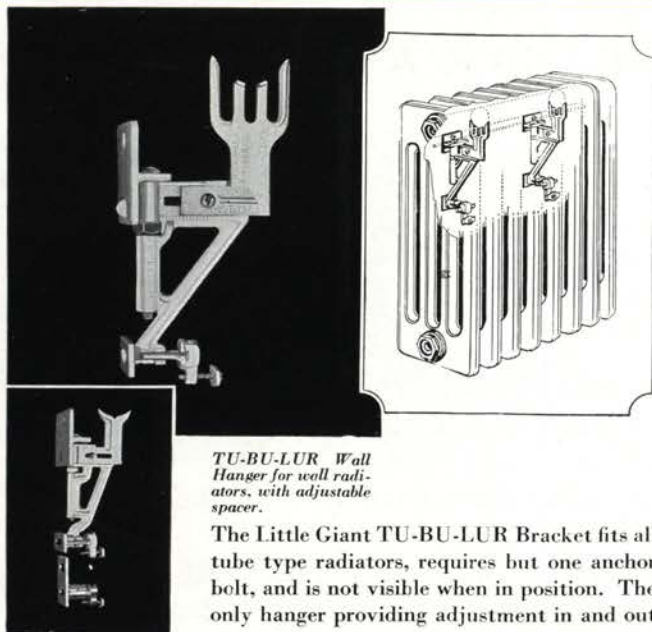

TU-BU-LUR Wall Hanger for wall radiators, with adjustable spacer.

The Little Giant TU-BU-LUR Bracket fits all tube type radiators, requires but one anchor bolt, and is not visible when in position. The only hanger providing adjustment in and out

from wall; for vertical alignment; laterally in either direction; for raising or lowering radiator; to line radiator in exact plumb. In one style, three sizes. Of certified malleable iron, painted navy gray. Delivered complete ready to install.

FOR WALL RADIATORS

LITTLE GIANT BOTTOM HUNG HANGERS

One bolt, two adjustments



Style L holds radiator 1½ inches from wall.

Style L for Wall Radiation and for 3 to 6 tube Radiators.

Style L for Double Wall and for 7 tube Radiators.

Style P for Wall Radiation and for 3 to 6 tube Radiators.

Style P for Double Wall and for 7 tube Radiators.



Style P holds radiator 2½ inches from wall.

PIN INDIRECT RADIATORS

Tappings on Indirect Radiators can be made at A, B, C, D, E, F, G, H, I, J, K, or L, but unless otherwise ordered they will be tapped at A and F, as follows:

Pin 10-ft. sections, 1½ in.; pin 15 and 20-ft. 2 in.; bushed as desired.

All pin Indirect sections are regularly connected with extra heavy malleable iron push nipples, but on special order extra heavy right and left hand screw nipples having hexagon nut at center can be furnished.

Sections are assembled at factory and shipped complete, unless especially ordered otherwise. Thus, the radiators can be thoroughly tested to prevent leaky joints and much of fitter's time in setting is saved.

When specially ordering sections shipped unassembled with bolts and nipples for putting together, always specify the number of stacks and number of sections in each stack, that the proper bolts may be sent.

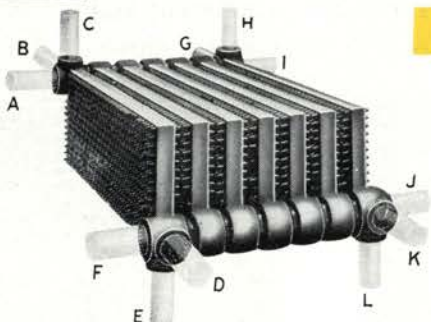

10 SQUARE FEET PER SECTION

Length of Section, Inches	Depth of Section, Inches	Depth Over All, Inches	Center to Center between Sections, Inches	Free Air Space between Sections, Sq. Ft.
36½	7¾	8½	3	.2703

Maximum tappings 1½" at A, F, I, and J and 1¼" at B, C, D, E, G, H, K, and L.

15 SQUARE FEET PER SECTION

Length of Section, Inches	Depth of Section, Inches	Depth Over All, Inches	Center to Center between Sections, Inches	Free Air Space between Sections, Sq. Ft.
36½	10½	11½	3	.2236

Maximum tappings 2" at A, F, I, and J and 1½" at B, C, D, E, G, H, K, and L.

20 SQUARE FEET PER SECTION

Length of Section, Inches	Depth of Section, Inches	Depth Over All, Inches	Center to Center between Sections, Inches	Free Air Space between Sections, Sq. Ft.
36	14	14¾	3½	.3494

Maximum tappings 2" at all openings.



CAPITOL MURAL AND MURAL CABINET RADIATORS



HARMONIOUS AS A MURAL DECORATION



The Capitol Mural Radiator is appropriate to its name, for installed under a window or recessed in the wall, it blends with the interior as beautifully as a mural painting.

Behind its solid sculptured front, the tubes act as flues, speeding the circulation of warmed air. The extra face surface increases heat radiation through the lower part of the room. Warmer floors and cooler ceilings result.

The Capitol Mural Radiator occupies less space than other types. Its design and strength are the perfected result of unhurried experiment and careful development. It is in every way worthy to carry the Capitol name.

The Capitol Mural Cabinet Radiator is pleasing in design and its cabinet effect blends with the best room appointments. The Capitol Mural Cabinet Radiator occupies less space than many other types and is a complete unit in itself. No enclosure is required. The beautiful grille tops which harmonize with the entire radiator design direct the air stream either upward or outward into the room.

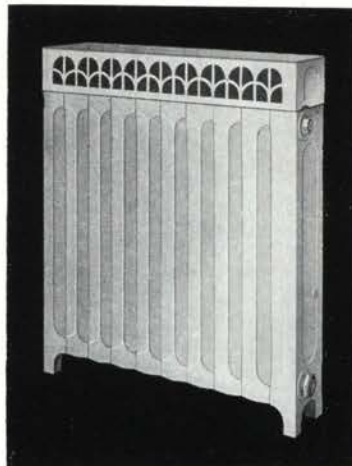

Front Outlet Grille



Top Outlet Grille

CAPITOL MURAL RADIATORS

ONE TUBE

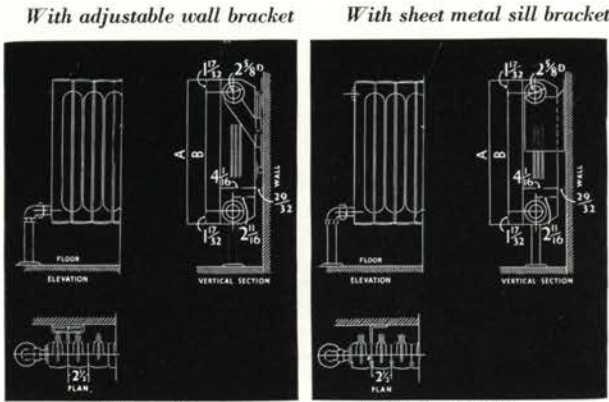

17-INCH HEIGHT, MEASUREMENT A, 17 1/4"; B, 13 1/4"
23-INCH HEIGHT, MEASUREMENT A, 22 1/4"; B, 19 1/4"

Number of Sections	*Length Inches	**17-inch Height 1 3/4 Square Feet Per Section	**23-inch Height 2 1/4 Square Feet Per Section
2	4 1/2	3 1/2	4 1/2
3	7	5 1/4	6 3/4
4	9 1/2	7	9
5	12	8 3/4	11 1/4
6	14 1/2	10 1/2	13 1/2
7	17	12 1/4	15 3/4
8	19 1/2	14	18
9	22	15 3/4	20 1/4
10	24 1/2	17 1/2	22 1/2
11	27	19 1/4	24 3/4
12	29 1/2	21	27
13	32	22 3/4	29 1/4
14	34 1/2	24 1/2	31 1/2
15	37	26 1/4	33 3/4
16	39 1/2	28	36
17	42	29 3/4	38 1/4
18	44 1/2	31 1/2	40 1/2
19	47	33 1/4	42 3/4
20	49 1/2	35	45

TWO TUBE

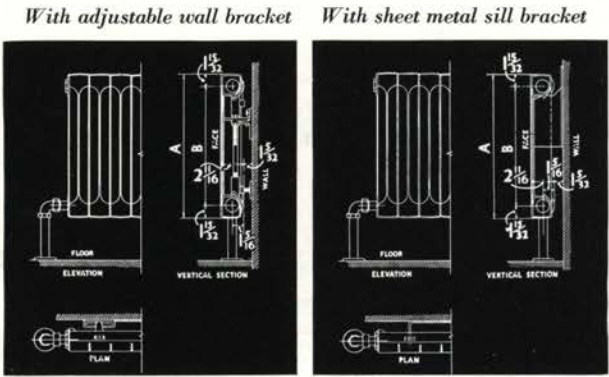

17-INCH HEIGHT, MEASUREMENT A, 17"; B, 14"
20-INCH HEIGHT, MEASUREMENT A, 19 3/4"; B, 16 1/2"
23-INCH HEIGHT, MEASUREMENT A, 22 3/4"; B, 19 3/4"

Assembly Number	*Length Inches	**17-inch Height 3 1/2 Sq. Ft. Per Succeeding Assembly Number	**20-inch Height 3 3/4 Sq. Ft. Per Succeeding Assembly Number	**23-inch Height 4 1/2 Sq. Ft. Per Succeeding Assembly Number
2	12 1/2	6 3/8	7 1/2	8 1/2
3	17 1/2	10	11 1/4	12 3/4
4	25	13 1/8	15	17
5	30	16 3/8	18 3/4	21 1/4
6	37 1/2	20	22 1/2	25 1/2
7	42 1/2	23 1/8	26 1/4	29 3/4
8	50	26 3/8	30	34
9	52 1/2	30	33 3/4	38 1/4
10	62 1/2	33 1/8	37 1/2	42 1/2
11	67 1/2	36 3/8	41 1/4	46 3/4
12	75	40	45	51
13	77 1/2	43 1/8	48 3/4	55 1/4
14	87 1/2	46 3/8	52 1/2	59 1/2
15	92 1/2	50	56 1/4	63 3/4
16	100	53 1/8	60	68

THREE TUBE

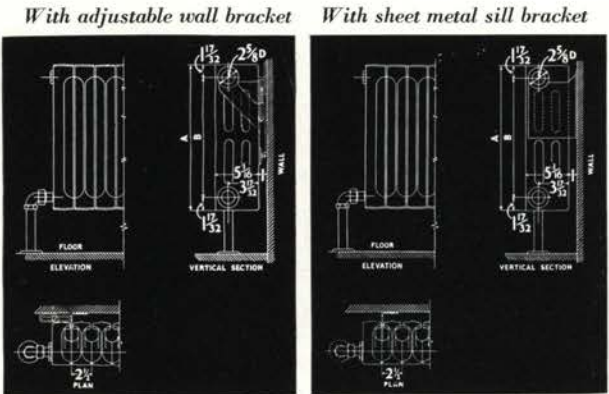

17-INCH HEIGHT, MEASUREMENT A, 17"; B, 13 1/4"
20-INCH HEIGHT, MEASUREMENT A, 20"; B, 16 1/4"
23-INCH HEIGHT, MEASUREMENT A, 22 3/4"; B, 19 1/4"

Number of Sections	*Length Inches	**17-inch Height 2 Sq. Ft. Per Section	**20-inch Height 2 1/2 Sq. Ft. Per Section	**23-inch Height 2 3/4 Sq. Ft. Per Section
2	4 1/2	4	4 1/2	5 1/8
3	7	6	7	8
4	9 1/2	8	9 1/2	10 3/8
5	12	10	11 1/2	13 1/8
6	14 1/2	12	14	16
7	17	14	16 1/2	18 3/8
8	19 1/2	16	18 1/2	21 1/8
9	22	18	21	24
10	24 1/2	20	23 1/2	26 3/8
11	27	22	25 1/2	29 1/8
12	29 1/2	24	28	32
13	32	26	30 1/2	34 3/8
14	34 1/2	28	32 1/2	37 1/8
15	37	30	35	40
16	39 1/2	32	37 1/2	42 3/8
17	42	34	39 1/2	45 1/8
18	44 1/2	36	42	48
19	47	38	44 1/2	50 3/8
20	49 1/2	40	46 1/2	53 1/8

FOUR TUBE

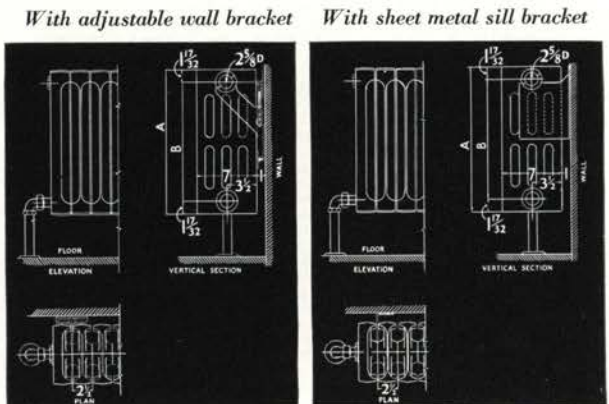

17-INCH HEIGHT, MEASUREMENT A, 17"; B, 13 1/4"
20-INCH HEIGHT, MEASUREMENT A, 20"; B, 16 1/4"
23-INCH HEIGHT, MEASUREMENT A, 22 3/4"; B, 19 1/4"

Number of Sections	*Length Inches	**17-inch Height 2 1/2 Sq. Ft. Per Section	**20-inch Height 3 Sq. Ft. Per Section	**23-inch Height 3 1/2 Sq. Ft. Per Section
2	4 1/2	5 1/8	6	6 3/8
3	7	8	9	10
4	9 1/2	10 3/8	12	13 1/8
5	12	13 1/8	15	16 3/8
6	14 1/2	16	18	20
7	17	18 3/8	21	23 1/8
8	19 1/2	21 1/8	24	26 3/8
9	22	24	27	30
10	24 1/2	26 3/8	30	33 1/8
11	27	29 1/8	33	36 3/8
12	29 1/2	32	36	40
13	32	34 3/8	39	43 1/8
14	34 1/2	37 1/8	42	46 3/8
15	37	40	45	50
16	39 1/2	42 3/8	48	53 1/8
17	42	45 1/8	51	56 3/8
18	44 1/2	48	54	60
19	47	50 3/8	57	63 1/8
20	49 1/2	53 1/8	60	66 3/8

CAPITOL MURAL RADIATORS

With adjustable wall bracket

With sheet metal sill bracket

**FIVE
TUBE**

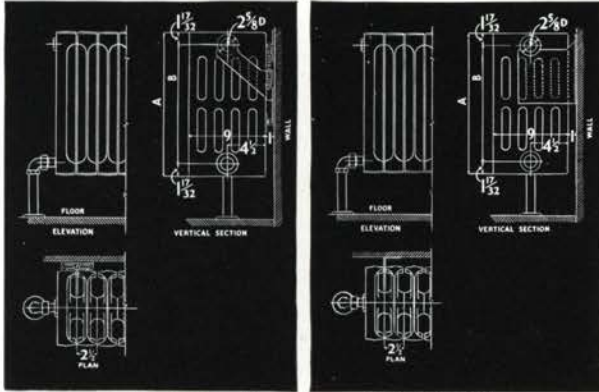

17-INCH HEIGHT MEASUREMENT, A, 17"; B, 13 11/16"
23-INCH HEIGHT MEASUREMENT, A, 22 3/4"; B, 19 11/16"

Number of Sections	*Length Inches	**17-inch Height 3 1/4 Sq. Ft. Per Section	**23-inch Height 4 Sq. Ft. Per Section
2	4 1/2	6 1/2	8
3	7	9 3/4	12
4	9 1/2	13	16
5	12	16 1/4	20
6	14 1/2	19 1/2	24
7	17	22 3/4	28
8	19 1/2	26	32
9	22	29 1/4	36
10	24 1/2	32 1/2	40
11	27	35 3/4	44
12	29 1/2	39	48
13	32	42 1/4	52
14	34 1/2	45 1/2	56
15	37	48 3/4	60
16	39 1/2	52	64
17	42	55 1/4	68
18	44 1/2	58 1/2	72
19	47	61 3/4	76
20	49 1/2	65	80

*Allow 1/2 inch for each bushing in estimating length of radiators.
 **Based on Engineering Standards of 215 degrees Fahrenheit steam temperature, 70 degrees room temperature and 240 B. t. u. per square foot per hour.
 TAPPINGS—1 1/4" top and bottom on one, two, three and four tube. 1 1/2" top and bottom on five tube. Bushed for steam or water as per specifications.
 CONNECTIONS—Both steam and water—extra heavy 1 1/4" right and left threaded nipples at top and bottom.
 NOTE—Two Tube Mural Radiators used for water systems are to be vented through tapped Top Plug provided on specification.

DIMENSIONS CAPITOL MURAL CABINET RADIATORS WITH FRONT OUTLET GRILLE

DIMENSIONS CAPITOL MURAL CABINET RADIATORS WITH TOP OUTLET GRILLE

Height Inches A	Over-all Height Inches H	Distance Between Tappings Inches B
20	23	13 1/8
23	26	16 1/8
26	28 3/4	19 1/8

For length see below

Radiator	Width Inches W
1 Tube	4 1/16
3 Tube	5 1/16
4 Tube	7
5 Tube	9

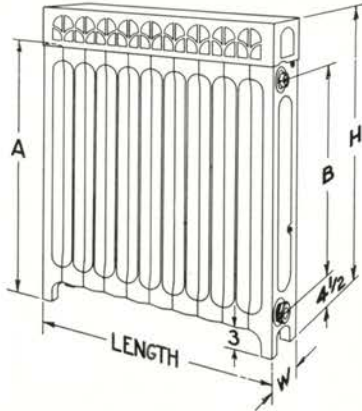

Height Inches A	Over-all Height Inches H	Distance Between Tappings Inches B
20	20 3/4	13 1/8
23	23 3/4	16 1/8
26	26 1/2	19 1/8

For length see below

Radiator	Width Inches W
1 Tube	4 1/16
3 Tube	5 1/16
4 Tube	7
5 Tube	9

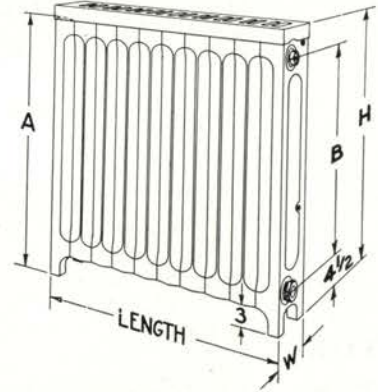

CAPITOL MURAL CABINET RADIATORS

Heating Surface—Square Feet for Steam or Water

Number of Sections	*Length Inches	ONE TUBE		THREE TUBE			FOUR TUBE			FIVE TUBE	
		**20-inch Height 1 3/4 Sq. Ft. Per Section	**26-inch Height 2 1/4 Sq. Ft. Per Section	**20-inch Height 2 Sq. Ft. Per Section	**23-inch Height 2 1/2 Sq. Ft. Per Section	**26-inch Height 2 3/4 Sq. Ft. Per Section	**20-inch Height 2 3/8 Sq. Ft. Per Section	**23-inch Height 3 Sq. Ft. Per Section	**26-inch Height 3 1/2 Sq. Ft. Per Section	**20-inch Height 3 1/4 Sq. Ft. Per Section	**26-inch Height 4 Sq. Ft. Per Section
6	14 1/2	10 1/2	13 1/2	12	14	16	16	18	20	19 1/2	24
7	17	12 1/4	15 3/4	14	16 1/2	18 3/8	18 3/8	21	23 1/4	22 3/4	28
8	19 1/2	14	18	16	18 3/8	21 1/2	21 1/2	24	26 3/8	26	32
9	22	15 3/4	20 1/4	18	21	24	24	27	30	29 1/4	36
10	24 1/2	17 1/2	22 1/2	20	23 1/2	26 3/8	26 3/8	30	33 1/8	32 1/2	40
11	27	19 1/4	24 3/4	22	25 2/8	29 1/8	29 1/8	33	36 2/8	35 3/4	44
12	29 1/2	21	27	24	28	32	32	36	40	39	48
13	32	22 3/4	29 1/4	26	30 1/8	34 2/8	34 2/8	39	43 1/8	42 1/4	52
14	34 1/2	24 1/2	31 1/2	28	32 2/8	37 1/8	37 1/8	42	46 2/8	45 1/2	56
15	37	26 1/4	33 3/4	30	35	40	40	45	50	48 3/4	60
16	39 1/2	28	36	32	37 1/8	42 2/8	42 2/8	48	53 1/8	52	64
17	42	29 3/4	38 1/4	34	39 2/8	45 1/8	45 1/8	51	56 2/8	55 1/4	68
18	44 1/2	31 1/2	40 1/2	36	42	48	48	54	60	58 1/2	72
19	47	33 1/4	42 3/4	38	44 1/8	50 2/8	50 2/8	57	63 1/8	61 3/4	76
20	49 1/2	35	45	40	46 2/8	53 1/8	53 1/8	60	66 2/8	65	80
21	52	36 3/4	47 1/4	42	49	56	56	63	70	68 1/4	84
22	54 1/2	38 1/2	49 1/2	44	51 1/8	58 2/8	58 2/8	66	73 1/8	71 1/2	88
23	57	40 1/4	51 3/4	46	53 2/8	61 1/8	61 1/8	69	76 2/8	74 3/4	92
24	59 1/2	42	54	48	56	64	64	72	80	78	96
25	62	43 3/4	56 1/4	50	58 1/2	66 2/8	66 2/8	75	83 1/2	81 1/4	100

*Allow 1/2 inch for each bushing in estimating length of radiators.
 **Based on Engineering Standards of 215 degrees Fahrenheit steam temperature, 70 degrees room temperature and 240 B. t. u. per square foot per hour.
 TAPPINGS—1 1/4 inches top and bottom on one, three and four tube. 1 1/2 inches top and bottom on five tube. Bushed for steam or water as per specifications.
 CONNECTIONS—Both steam and water—extra heavy 1 1/4-inch right and left threaded nipples at top and bottom.

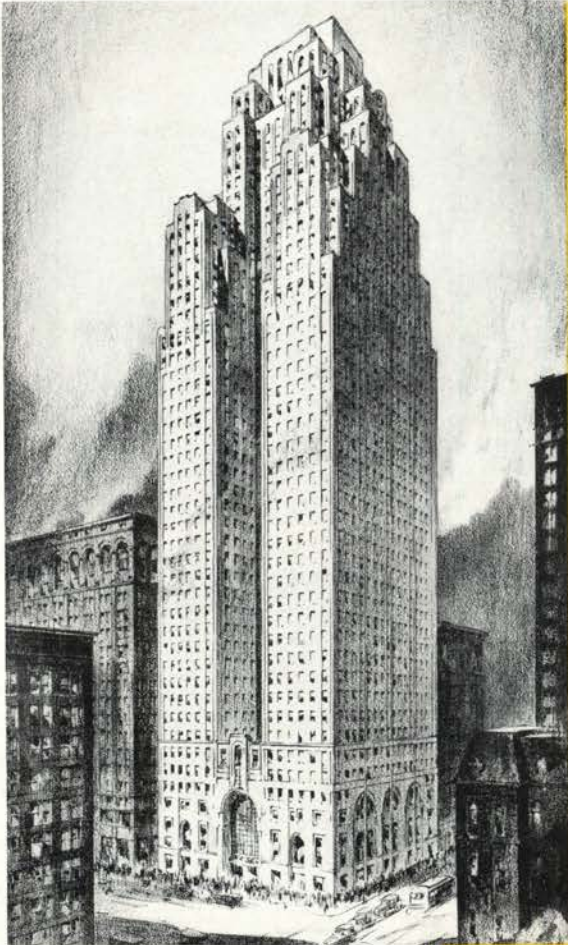

Smith, Hinchman & Grylls, Detroit, Mich., Architects
 H. Kelly & Co., Detroit, Mich., Heating Contractors

*Many large
 office buildings are
 heated with . . .*
CAPITOL RADIATORS

At the left
THE PENOBSCOT BUILDING
DETROIT • MICHIGAN

*Ideal for
 office buildings . . .*
 **CAPITOL**
MURAL RADIATORS

At the right
THE TOWER BUILDING
BOSTON • MASSACHUSETTS



Thomas M. James Co., Boston, Mass., Architects
 Downey Co., Boston, Mass., Heating Contractors

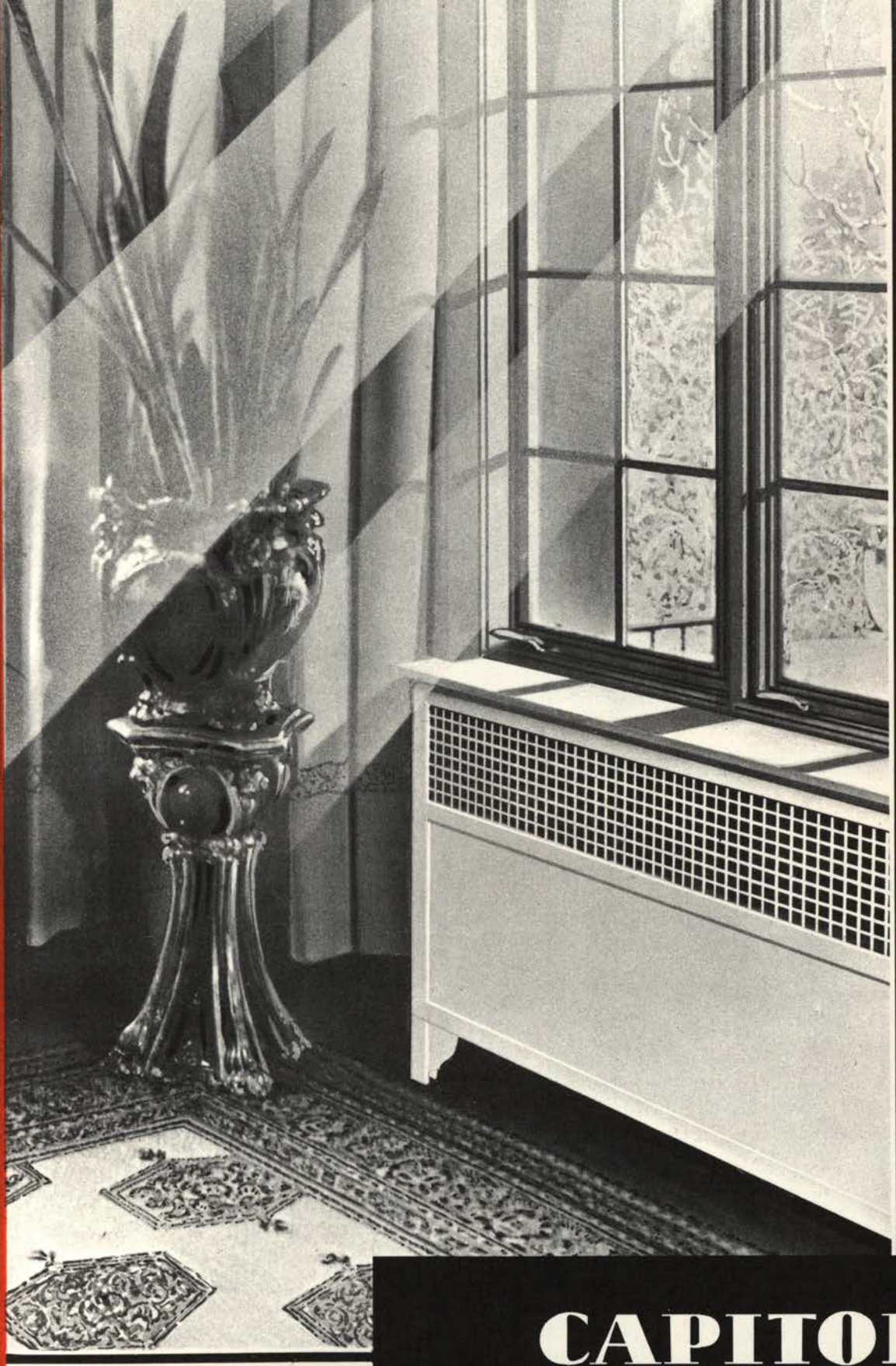

CAPITOL
Finca
RADIATORS

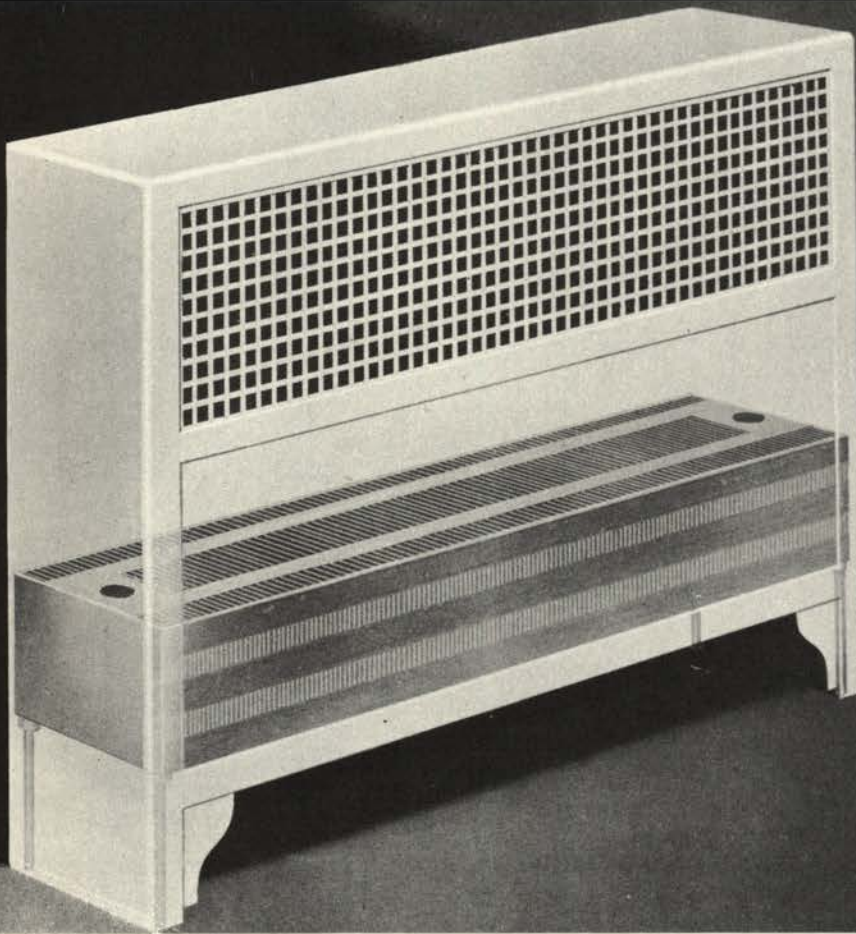

THE CAPITOL *Fincast* RADIATOR

THE ONE PIECE RADIATOR BUILT WITHOUT JOINTS

A new industry was born in the middle of the last Century when the practice of heating buildings with steam or hot water began.

The first radiators were crudely made from lengths of iron pipe.

But with the advent of radiators made from cast iron, buildings of all types could be heated practically and economically. The first radiators were large and bulky. With continuous refinement radiator shapes became more graceful, beauty supplanted bulk.

Then came the practice of concealing radiators within the walls of the room. Radiators of large capacity and small size were needed.

All of these many radiators possessed one common characteristic—they all were made with JOINTS. Joints between iron pipes, joints between sections or joints between tubes and fins. In all cases these joints must remain tight to prevent leakage or a reduction of heat transfer.

With the introduction of the Fincast Radiator a revolutionary event occurred. A radiator was built *without joints*. The Fincast Radiator is cast in one piece, of cast iron, without joints.

UNITED STATES RADIATOR CORPORATION

DETROIT, MICHIGAN

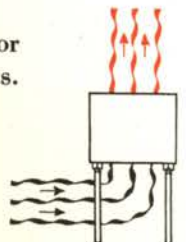

THE *Fincast* RADIATOR • *Made of cast iron*

There are many reasons for the widespread use of cast iron in the construction of radiators.

Cast iron can be molded into the necessary shapes for the greatest efficiency. Cast iron, as a metal, has certain surface characteristics which make for maximum emission of heat from the surface of the radiator to the air flowing over and through it.

In the Fincast Radiator all the many advantages of cast iron construction are combined with extreme compactness.

To accomplish this, new foundry methods were created and new metallurgical practices employed.

The Capitol Fincast Radiator is furnished in four depths. $3\frac{1}{2}$, $5\frac{3}{8}$, $7\frac{1}{4}$ and $10\frac{5}{8}$ inches. The lengths are from 18 to 63 inches, in steps of five inches. The height of all radiators is $4\frac{1}{2}$ inches.

The $3\frac{1}{2}$ and $5\frac{3}{8}$ inch depths of Fincast Radiators are made with one centrally located fluid chamber. The $7\frac{1}{4}$ and $10\frac{5}{8}$ inch depths have two proportionally spaced, interconnected fluid chambers. The fluid chamber, $\frac{1}{2}$ inch wide and 4 inches high, is approximately as high as the radiator. Integral with it are many cast iron fins, which are cast together at their vertical edges forming the outer side walls of the radiator. Thus are formed many unobstructed air passages through the radiator, bounded on the inner side by the wall of the fluid chamber and on the outer side by the wall of the radiator.

A group of No. 7 Depth Fincast Radiators is illustrated below.

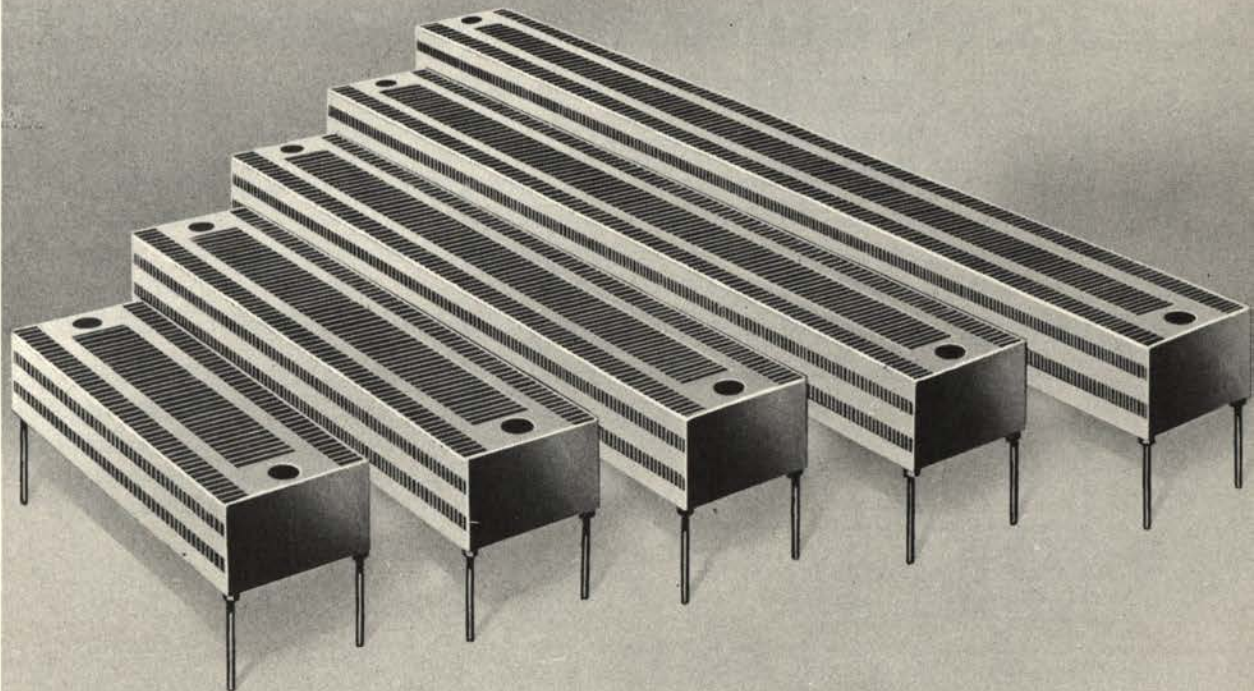

Fincast SUPERIORITY

ALL CAST IRON—NO JOINTS, NIPPLES, FERRULES, WELDS

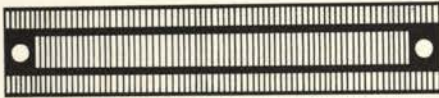

Capitol Fincast Radiators are unique in that they are *made without joints*. Each Fincast Radiator is one homogeneous casting. One Unit. One Piece. All of Cast Iron. Nothing to wear out. No parts to corrode. Long Life.

LARGE FLUID CHAMBERS

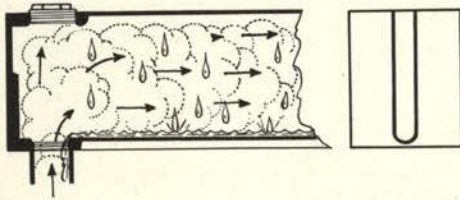

An important feature in the Fincast Radiator. The fluid chamber in the Fincast Radiator is $\frac{1}{2}$ -inch wide and four inches high. Heat is transferred direct from the very top to bottom of fins. There is no interference between steam and condensation. No waterlogging. Ample amount of the heating medium within the radiator at all times insures equal output at both supply and return ends.

AMPLE INTERNAL CROSS SECTIONAL AREA

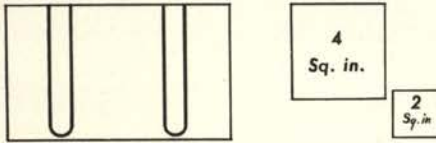

The ample volume of the fluid chamber is illustrated by a comparison between its cross sectional area and that of the largest supply pipe that may be used with it in actual practice. In the example illustrated the total cross sectional area of the fluid chambers of the No. 7 Depth radiator is 4 sq. in. against 2 sq. in. for $1\frac{1}{2}$ " supply pipe.

STRONG BOX LIKE CONSTRUCTION

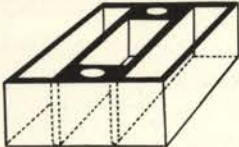

The Fincast Radiator is strong and rigid, which enables it to endure much abuse on the job during construction. Its box like construction is illustrated at the left. Note that there are no joints to become loosened through rough handling. No possibility of fin separating from fluid chamber with the resultant loss in capacity.

FULLY SUITED TO HOT WATER SYSTEMS

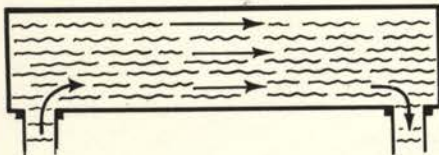

It will be noted that the fluid chamber of the Fincast Radiator approximates the full height of the fins. This means that each fin transfers its heat directly from the hot water within the radiator. Again the full area of the large fluid chamber insures that ample heating medium is within the radiator at all times with minimum resistance to water circulation.

SPECIAL FINCAST RADIATOR SUPPLY VALVE

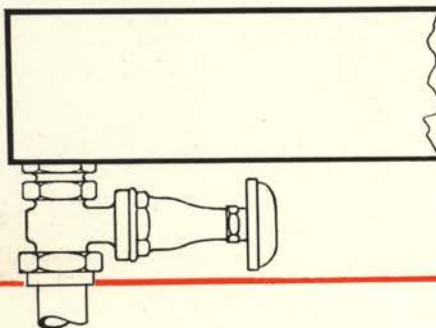

For beauty of appearance, years of trouble free service, convenience to owner and as a time saver to the Heating Contractor, the new Fincast Radiator Valve stands alone. It is a double union packless gate valve which is installed directly to the radiator. It makes the use of elbows and pipe fittings unnecessary.



CAPITOL *Enclosures*

While Capitol Fincastr Radiators do their work quietly and efficiently concealed within the walls of the rooms, the enclosures are the products which are visible to the occupants.

They should, therefore, be pleasing in appearance and harmonize well with the decorative scheme of the room.

Capitol Enclosures are eminently fitted for this task. They are well and carefully made. Manufactured accurately to catalog dimensions their installation is easily accomplished.

Many styles and sizes are available. The Enclosures may be completely or partially set within the walls. Metal or Plaster Fronts may be used. Or the Enclosures may be set in the room against the wall. Every type of enclosure may be had with a damper to control the flow of heated air into the room. Humidifier Pans for moistening the air are available if desired. These types are described in detail on page eight.

In the illustration above the Style R Enclosure is used. The grained finish harmonizes with the woodwork of the room.

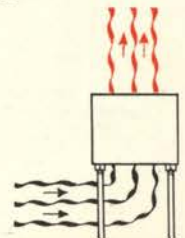



Beauty

Capitol Enclosures harmonize fully with modern interior decoration. The Grille is of simple design, effective yet unobtrusive. Often the location of a Fincast Radiator and Enclosure under a window enhances the whole decorative scheme by completing the panel effect of the window.

Healthful Heat

Rooms heated with Capitol Fincast Radiators are healthy places for children to play in. Capitol Enclosures may be equipped with Humidifier Pans if desired. Thus moisture is added to the heated air.

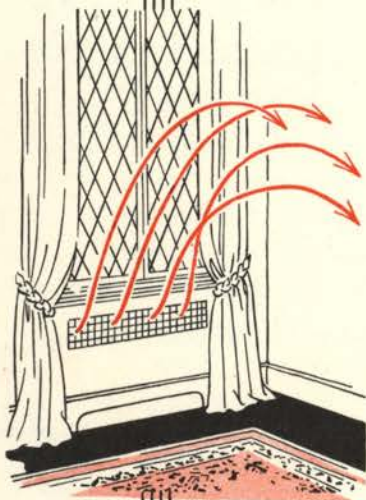

Comfortable Heat

Due to the design of the Enclosures the heated air is projected mildly into the room in such a way as to more nearly equalize the temperature differences at various heights within the room. With the mild circulation thus created the ceiling temperatures are not excessive and the floor temperatures are warmer.

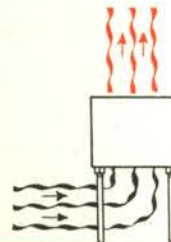

Instant Control

Capitol Enclosures may be equipped with dampers which make instant regulation of the amount of heat flowing into the room possible. It may be desired to heat only the living rooms at certain periods of the day. All that is necessary is to close the dampers in the Enclosures in those rooms where heat is not desired. Bed Rooms can be quickly heated on cold mornings by opening the Enclosure dampers.



Compactness

Comparatively small space is necessary for Capitol Fincast Radiators due to their compactness and large heating capacity per lineal inch. It is, therefore, possible to place the radiator where desired.

Practical Heat

Floor space is usually at a premium both in homes and offices. The concealing of the Fincast Radiator within the walls of the room makes space available that otherwise could not be used for the locating of furniture or office desks.

Cast iron is known to possess unparalleled long life, which insures many years of service from Fincast Radiators. There is nothing on the Fincast Radiator to wear out!

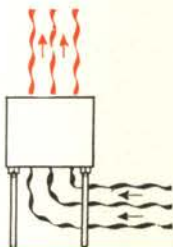

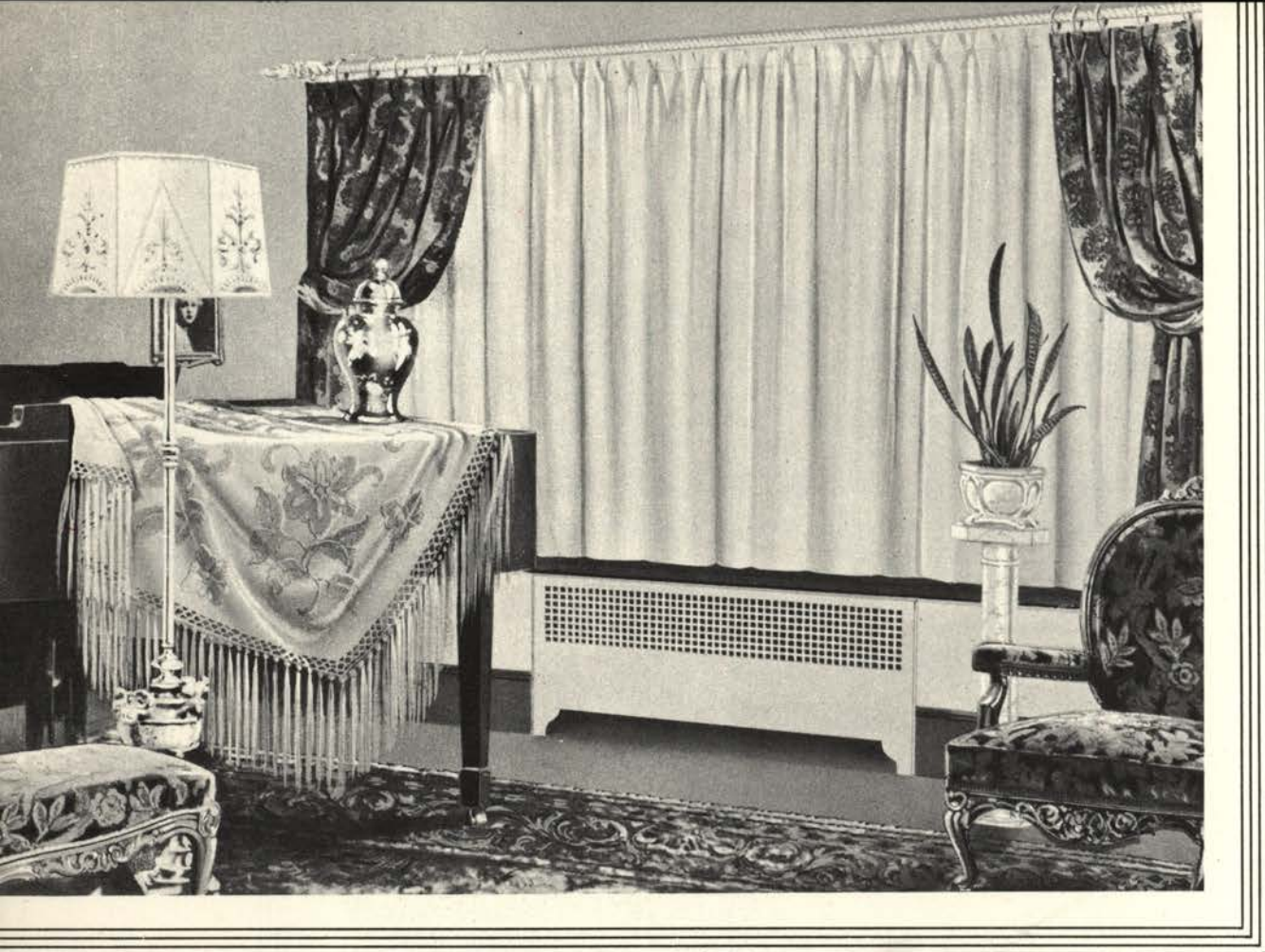

DESCRIPTION OF *Enclosures*

- STYLE R** • All metal enclosure for partial or complete recessing. Has removable front. Can be equipped with humidifier pan.
- STYLE C** • All metal incasement for free standing installations not recessed. Can be equipped with humidifier pan.
- STYLE H** • Metal Panel Front with beveled edges for complete recessing. Front extends to base board.
- STYLE HA** • Metal Panel Front with beveled edges for complete recessing. Extends to floor with metal arch inlet. Note the illustration above.
- STYLE HB** • Same as STYLE HA except with liner box. For use where Metal Front is to be installed flush with the plaster line.
- STYLE L** • Metal Outlet Grille and frame only, for Plaster.
- STYLE LP** • Plaster Front for complete recessing consisting of Outlet Grille and Frame and Plaster Panel to inlet.
- STYLE LPG** • Same as STYLE LP but including Grille Inlet Panel at bottom.
- STYLE LB** • Enclosure for Plaster. For complete or partial recessing. Consists of Outlet Grille Panel and Frame, Plaster Panel to inlet and Liner Box.
- STYLE LBG** • Same as STYLE LB but including Grille Inlet Panel at bottom.
- DAMPERS** • All the above fronts and enclosures can be equipped with positive control dampers.

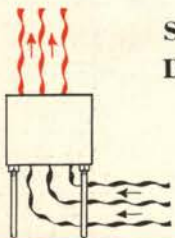

TYPICAL PIPING CONNECTIONS

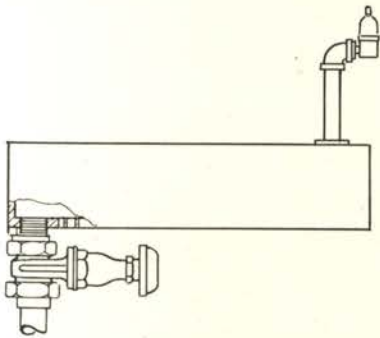

One Pipe, Steam.

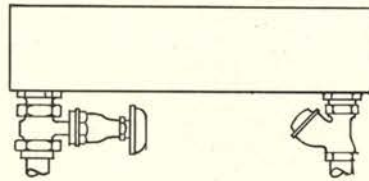

Vapor System.

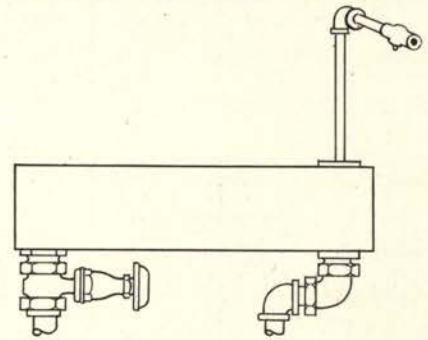

Hot Water System.

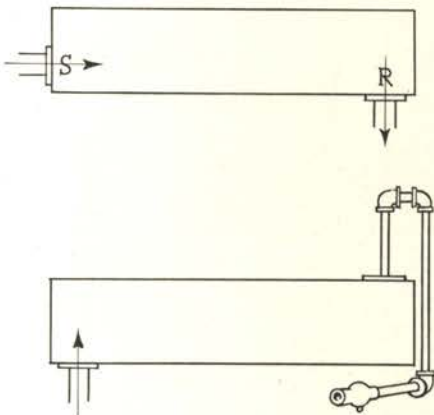
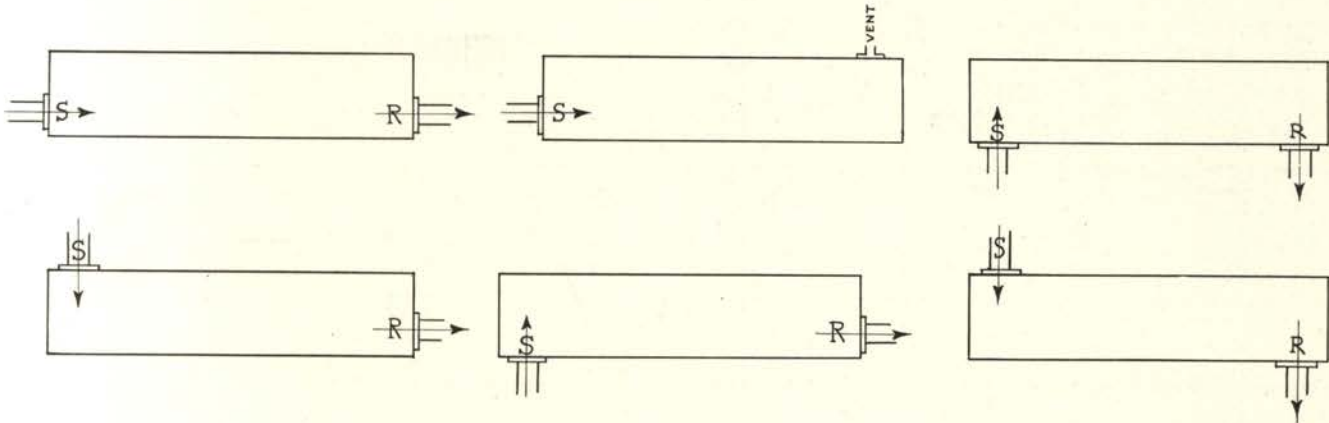

Another method of venting on hot water systems.

Style R Enclosure showing removable front with damper.

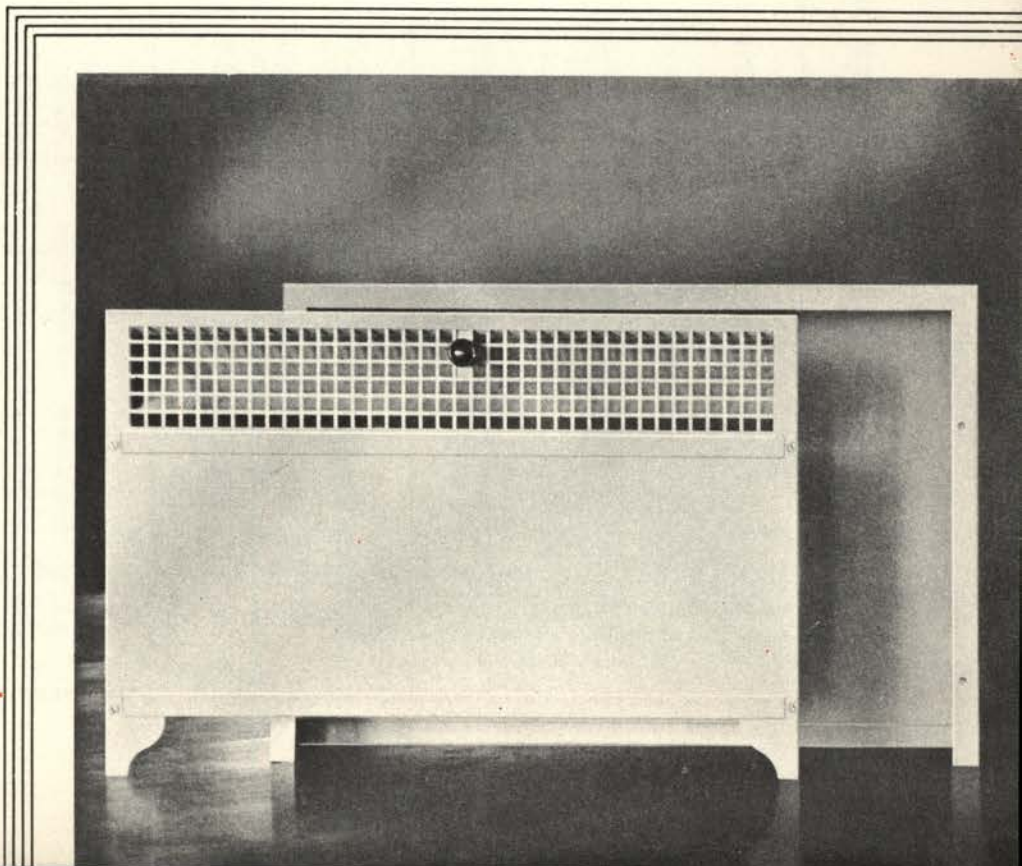

STEAM OR WATER RATINGS

Front Outlet Grille—Steam, 240 B.t.u.; Water, 150 B.t.u.

Stack Height Inches	Radiator Length Inches	Radiator Length Inches	Radiator Length Inches	Radiator Length Inches	Radiator Length Inches	Radiator Length Inches	Radiator Length Inches	Radiator Length Inches	Radiator Length Inches	Radiator Length Inches
	18	23	28	33	38	43	48	53	58	63

No. 3 DEPTH

14"	10.2	13.1	15.9	18.7	21.6	24.4	27.3	30.1	32.9	35.8
17"	11.3	14.5	17.6	20.8	23.9	27.0	30.2	33.3	36.5	39.6
20"	12.2	15.6	19.0	22.4	25.8	29.2	32.6	36.0	39.4	42.8
24"	13.0	16.7	20.3	24.0	27.5	31.1	34.8	38.4	42.0	45.6
30"	13.9	17.7	21.6	25.4	29.3	33.1	37.0	40.8	44.7	48.5
36"	14.5	18.6	22.6	26.7	30.7	34.7	38.8	42.8	46.9	50.9
42"	15.0	19.2	23.3	27.5	31.7	35.8	40.0	44.1	48.3	52.5
48"	15.5	19.8	24.1	28.4	32.8	37.1	41.4	45.7	50.0	54.3
54"	15.9	20.3	24.7	29.1	33.6	38.0	42.4	46.8	51.2	55.6
60"	16.3	20.8	25.4	29.9	34.4	39.0	43.5	48.0	52.5	57.1

No. 5 DEPTH

14"	14.2	18.2	22.1	26.1	30.0	34.0	37.9	41.9	45.8	49.8
17"	15.9	20.3	24.7	29.1	33.6	38.0	42.4	46.8	51.2	55.6
20"	17.4	22.2	27.1	31.9	36.7	41.6	46.4	51.3	56.1	60.9
24"	19.4	24.7	30.1	35.5	40.9	46.3	51.6	57.0	62.4	67.8
30"	21.5	27.4	33.4	39.4	45.3	51.3	57.3	63.2	69.2	75.2
36"	22.9	29.2	35.6	41.9	48.3	54.6	61.0	67.3	73.7	80.0
42"	24.0	30.6	37.3	43.9	50.6	57.2	63.9	70.5	77.2	83.9
48"	24.9	31.9	38.8	45.7	52.7	59.6	66.5	73.5	80.4	87.3
54"	25.7	32.9	40.0	47.2	54.3	61.4	68.6	75.7	82.9	90.0
60"	26.4	33.7	41.0	48.3	55.7	63.0	70.3	77.6	85.0	92.3

No. 7 DEPTH

14"	18.0	23.0	28.0	33.0	38.0	43.0	48.0	53.0	58.0	63.0
17"	20.9	26.7	32.5	38.3	44.1	49.9	55.7	61.5	67.3	73.1
20"	23.0	29.4	35.8	42.2	48.6	55.0	61.4	67.8	74.2	80.6
24"	25.0	32.0	38.9	45.9	52.8	59.8	66.7	73.7	80.6	87.6
30"	27.0	34.5	41.9	49.4	56.9	64.4	71.9	79.4	86.9	94.4
36"	28.3	36.2	44.1	51.9	59.8	67.7	75.6	83.4	91.3	99.2
42"	29.5	37.7	45.9	54.1	62.3	70.5	78.7	86.9	95.1	103.3
48"	30.5	39.0	47.4	55.9	64.4	72.8	81.3	89.8	98.3	106.7
54"	31.4	40.1	48.8	57.5	66.2	74.9	83.6	92.3	101.0	109.7
60"	32.2	41.1	50.1	59.0	68.0	76.9	85.9	94.8	103.8	112.7

No. 10 DEPTH

14"	22.9	29.2	35.6	41.9	48.3	54.6	61.0	67.3	73.7	80.0
17"	27.0	34.5	41.9	49.4	56.9	64.4	71.9	79.4	86.9	94.4
20"	30.0	38.3	46.6	55.0	63.3	71.6	80.0	88.3	96.6	105.0
24"	32.9	42.1	51.2	60.4	69.5	78.6	87.8	96.9	106.1	115.2
30"	35.9	45.8	55.8	65.8	75.7	85.7	95.7	105.6	115.6	125.6
36"	38.1	48.7	59.3	69.9	80.4	91.0	101.6	112.2	122.8	133.4
42"	39.8	50.8	61.9	72.9	84.0	95.0	106.1	117.1	128.2	139.2
48"	41.2	52.7	64.1	75.6	87.1	98.5	110.0	121.4	132.9	144.3
54"	42.6	54.4	66.2	78.0	89.8	101.7	113.5	125.3	137.1	148.9
60"	43.7	55.9	68.0	80.2	92.3	104.4	116.6	128.7	140.9	153.0

WHEN TOP OUTLET GRILLES ARE USED, THE ABOVE RATINGS SHOULD BE INCREASED AS FOLLOWS:

14" Stack Height multiply above ratings by 1.16

17" Stack Height multiply above ratings by 1.12

20" Stack Height multiply above ratings by 1.09

24" Stack Height multiply above ratings by 1.07

RECESS DIMENSIONS

LENGTHS

Radiator Length, Inches	18	23	28	33	38	43	48	53	58	63
Recess Length—Styles R, LB, HB	19½	24½	29½	34½	39½	44½	49½	54½	59½	64½
Recess Length—Styles H, HA, L, LP	19	24	29	34	39	44	49	54	59	64

HEIGHTS*

Stack Height, Inches	14	17	20	24	30	36	42	48	54	60
Recess Height—Styles R, LB	20¼	23¼	26¼	30¼	36¼ ^①	42¼	48¼	54¼	60¼	66¼
Recess Height—Styles H, HA, HB, LP	19½	22½	25½	29½ ^②	35½	41½	47½	53½	59½	65½

* All height dimensions are from finish floor.

① Maximum Height—Style R.

② Maximum Height—Styles H, HA and HB

DEPTHS*

Radiator Depth Number	3	5	7	10
Recess Depth—Style R	4⅛	6	7⅞	11¼
Recess Depth—Styles H, HA	3¾	5⅝	7½	10⅞
Recess Depth—Styles L, LP, LB	4¾	6⅝	8½	11⅞
Recess Depth—Style HB	3⅞	5¾	7⅝	11

* All depth dimensions are from Finish Plaster Line.

RADIATOR MEASUREMENTS

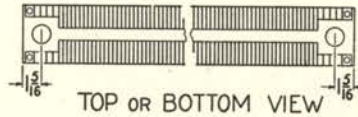
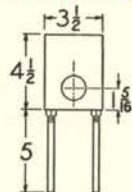
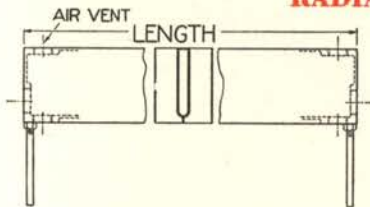

No. 3 Radiator

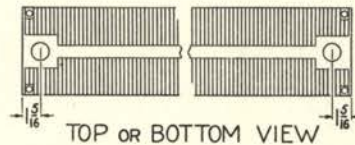
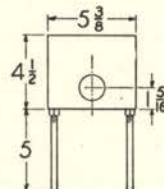
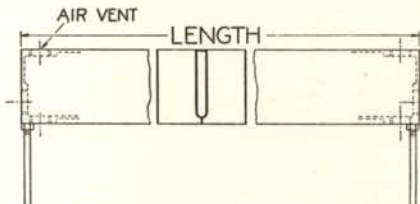

No. 5 Radiator

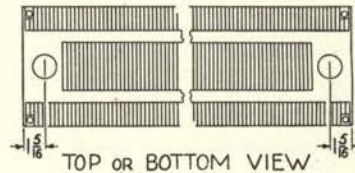
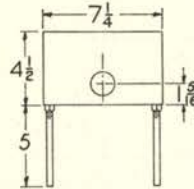
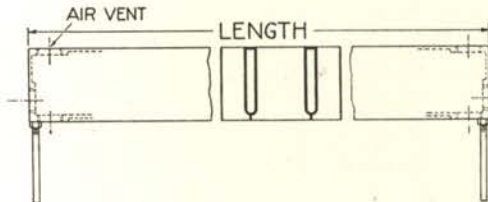

No. 7 Radiator

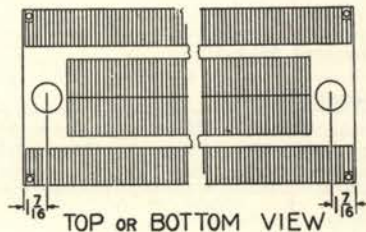
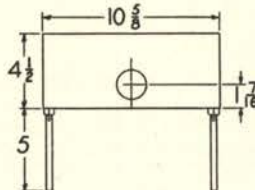
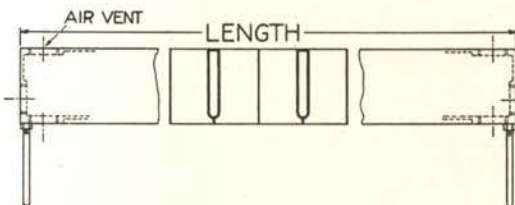

No. 10 Radiator

STYLE C INCASEMENT AND STYLE R ENCLOSURE

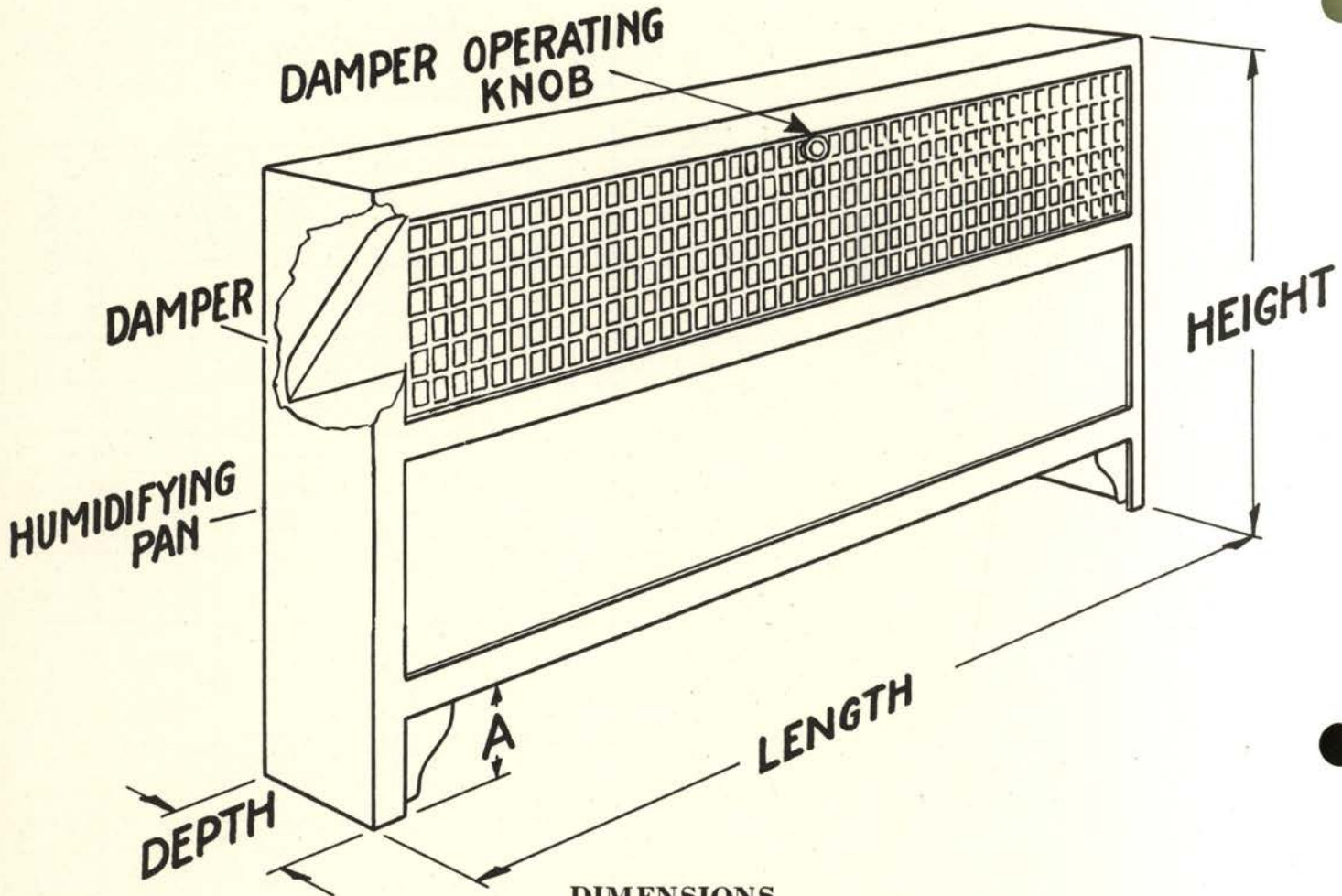

DIMENSIONS

Lengths ①

Recess Length, Style R	19½"	24½"	29½"	34½"	39½"	44½"	49½"	54½"	59½"	64½"
Length, Styles C and R	19"	24"	29"	34"	39"	44"	49"	54"	59"	64"
Radiator Length, Inches—Top or Bottom Connection	18	23	28	33	38	43	48	53	58	63

Heights ②

Recess Height, Style R	20¼"	23¼"	26¼"	30¼"	36¼"
Incasement Height, Style C	20"	23"	26"	30"	36"
Enclosure Height, Style R	20"	23"	26"	30"	36"
Stack Height	14"	17"	20"	24"	30"

Depths ③

Recess Depth—Style R	4⅛"	6"	7⅞"	11¼"
Incasement Depth, Style C	4"	5⅞"	7¾"	11⅞"
Enclosure Depth, Style R	4"	5⅞"	7¾"	11⅞"
Radiator Depth Number	3	5	7	10

Inlet Heights

Radiator Depth No.	3 and 5	7 and 10
A—Incasement, Style C	3½"	4⅝"
A—Enclosure, Style R	3½"	4⅝"

① Incasements and Enclosures may be equipped with dampers.

② An evaporator pan for humidification can be furnished for Incasements and Enclosures in 5, 7 and 10 depths and in 23, 26, 30 and 36 heights.

③ Recess depth is less than Enclosure depth shown when Enclosure projects beyond wall.

STYLE H, HA AND HB ENCLOSURES AND FRONTS

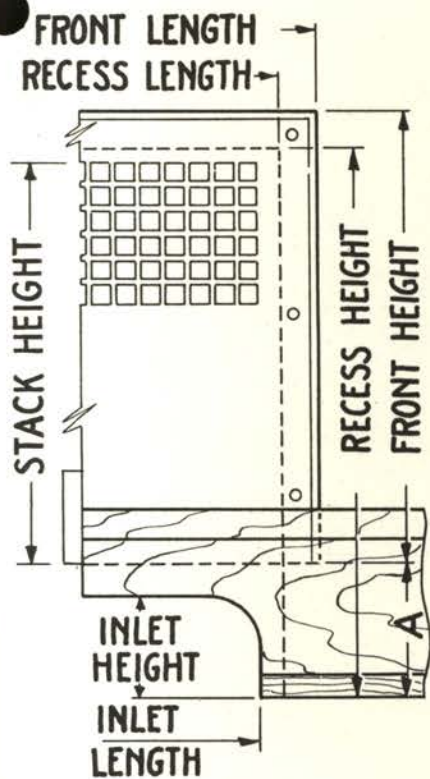

H
FRONT ONLY

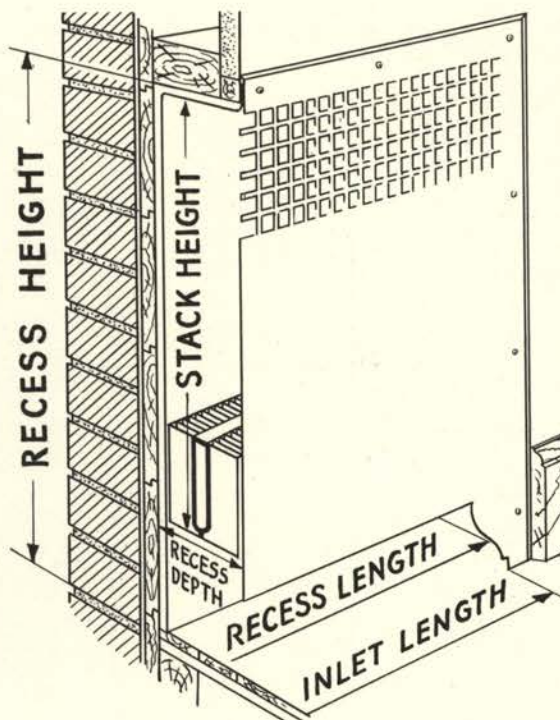

HB
FRONT WITH LINER BOX

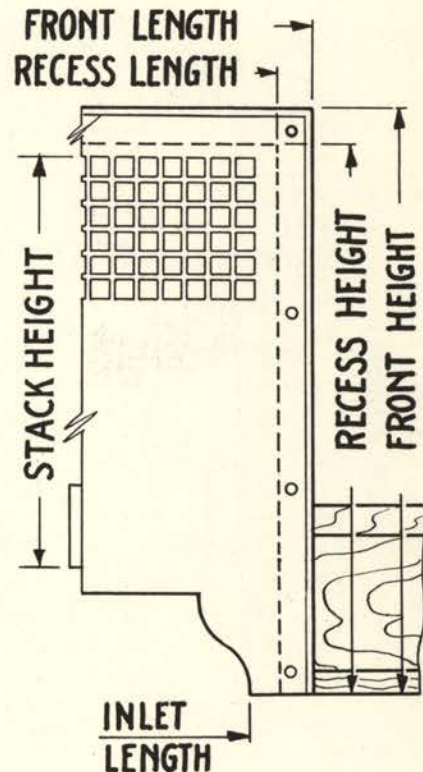

HA
FRONT ONLY

DIMENSIONS

Lengths

Recess Length, Style HB	19½"	24½"	29½"	34½"	39½"	44½"	49½"	54½"	59½"	64½"
Recess Length, Styles H, HA	19"	24"	29"	34"	39"	44"	49"	54"	59"	64"
Front Length, Styles H, HA, HB	21¾"	26¾"	31¾"	36¾"	41¾"	46¾"	51¾"	56¾"	61¾"	66¾"
Radiator Length, Inches—Top or Bottom Connection	18	23	28	33	38	43	48	53	58	63

Heights

Recess Height from Finish Floor, Style H, HA, HB	19½"	22½"	25½"	29½"
Stack Height	14"	17"	20"	24"
Front Height, Styles HA and HB	20⅞"	23⅞"	26⅞"	30⅞"
Front Height, Style H, Nos. 3 and 5 Radiator Depth	17⅞"	20⅞"	23⅞"	27⅞"
Front Height, Style H, Nos. 7 and 10 Radiator Depth	16"	19"	22"	26"

Depths and Inlet Heights

Recess Depth, Style HB	3⅞"	5¼"	7⅞"	11"
Recess Depth, Style H and HA	3¾"	5⅝"	7½"	10⅞"
Radiator Depth Number	3	5	7	10
Inlet Height, Style H	3½"	3½"	4⅝"	4⅝"
Inlet Height, Styles HA and HB	4"	4"	4"	4"
Bottom of Front to Finish Floor (A), Style H	3¾"	3¾"	4⅞"	4⅞"

STYLE L, LP AND LB PLASTER FRONTS AND ENCLOSURES

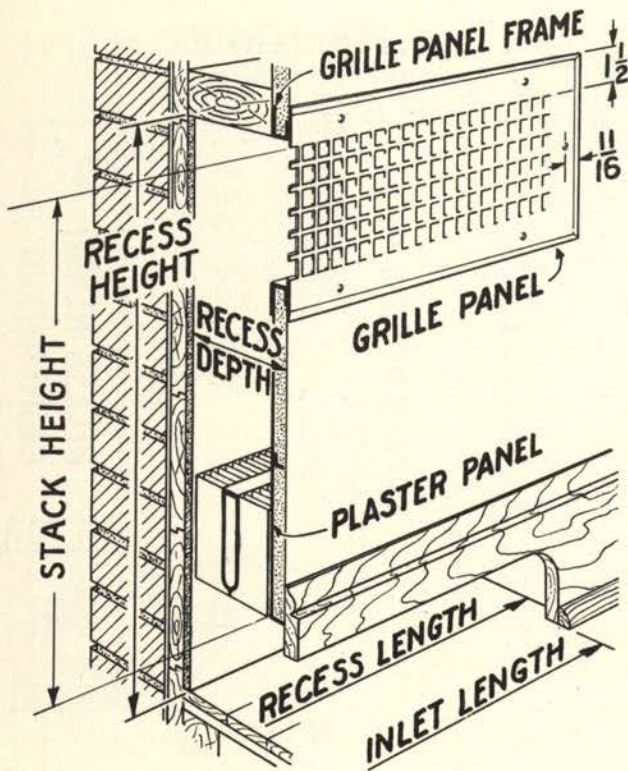

STYLE LP

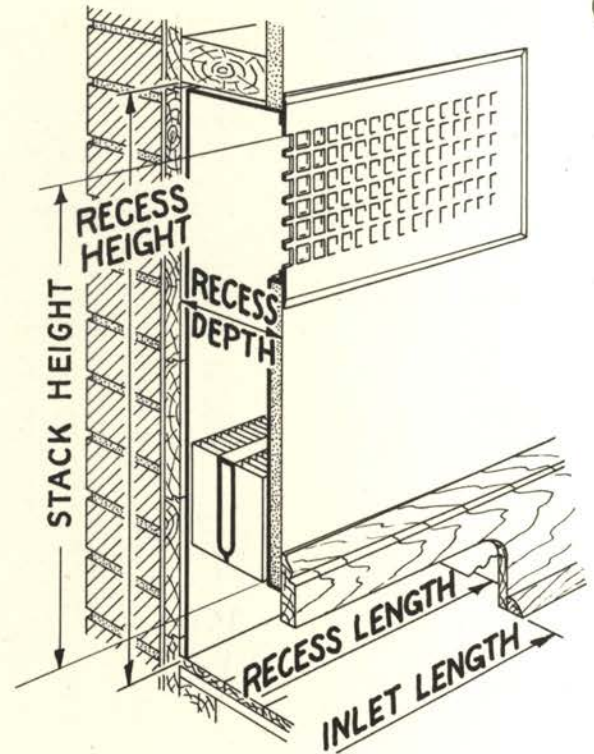

STYLE LB

DIMENSIONS Lengths

Recess Length without Enclosure, LP	19"	24"	29"	34"	39"	44"	49"	54"	59"	64"
Recess Length with Enclosure, LB	19½"	24½"	29½"	34½"	39½"	44½"	49½"	54½"	59½"	64½"
Plaster Panel and Grille Panel Length	20¼"	25¼"	30¼"	35¼"	40¼"	45¼"	50¼"	55¼"	60¼"	65¼"
Grille Panel Frame Length Inside	18⅞"	23⅞"	28⅞"	33⅞"	38⅞"	43⅞"	48⅞"	53⅞"	58⅞"	63⅞"
Inlet Length	14½"	19½"	24½"	29½"	34½"	39½"	44½"	49½"	54½"	59½"
Radiator Length, Inches—Top or Bottom Connection	18"	23"	28"	33"	38"	43"	48"	53"	58"	63"

Heights

Recess Height with Enclosure, LB	23¼"	26¼"	30¼"	36¼"	42¼"	48¼"	54¼"	60¼"	66¼"
Recess Height without Enclosure, LP	22½"	25½"	29½"	35½"	41½"	47½"	53½"	59½"	65½"
Stack Height	17"	20"	24"	30"	36"	42"	48"	54"	60"
Height—Top of Grille Panel to Finished Floor	23½"	26½"	30½"	36½"	42½"	48½"	54½"	60½"	66½"

Height Dimensions of Style L Parts

Radiator Depth No.	3 and 5	7 and 10
Grille Panel Height	7⅛"	9⅝"
Grille Panel Frame Opening Height	5⅞"	7⅞"
Min. Inlet Height (for wood base board across inlet)	3½"	4⅝"

Depths

Recess Depth from Finished plaster, LB	4¾"	6⅝"	8½"	11⅞"
Radiator Depth Number	3	5	7	10

ILLUSTRATIONS OF TYPICAL *Enclosure* INSTALLATIONS

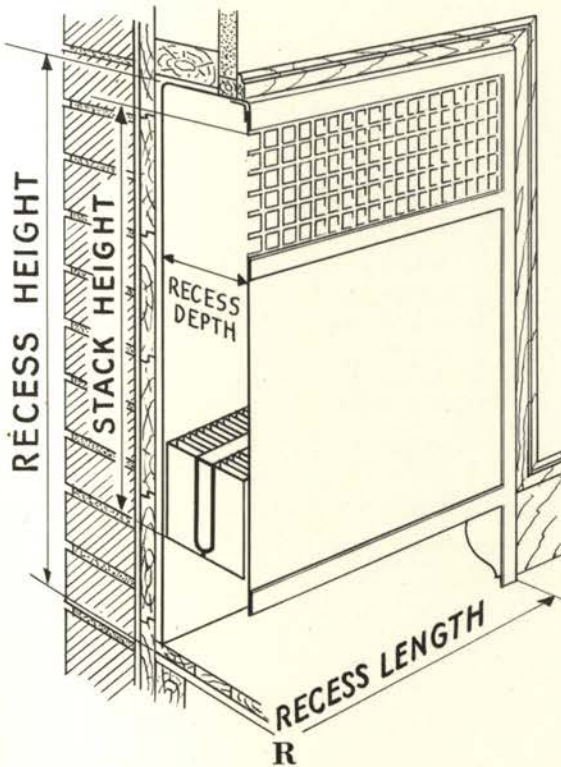

R
Partially Recessed

At the left, a typical method of treatment showing Style R enclosure partially recessed. The use of the molding strip around the enclosure insures a close fit and eliminates possible separation of plaster from enclosure edges.

If a flush fitting of enclosure front with plaster is desired use Style HB shown at the right.

The metal front overlaps the plaster making a very close joint, as shown.

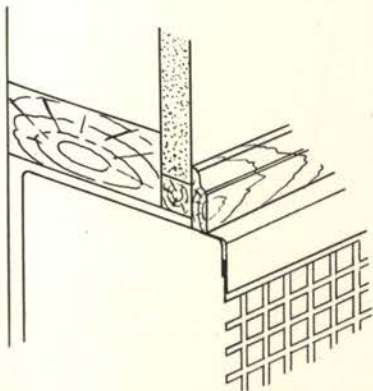
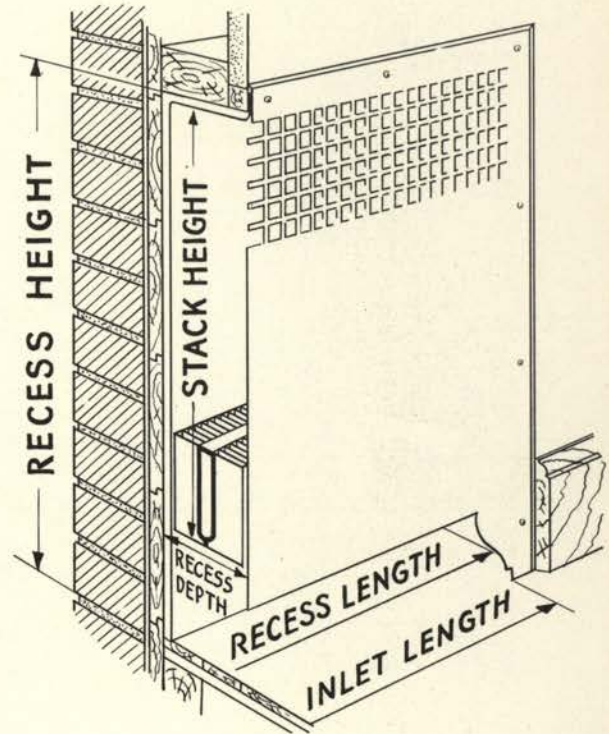

Above is an enlarged portion of a Style R enclosure, partially recessed, showing application of molding strip.

Below is shown another method of installing a Style R enclosure, partially recessed through the use of a plaster corner bead

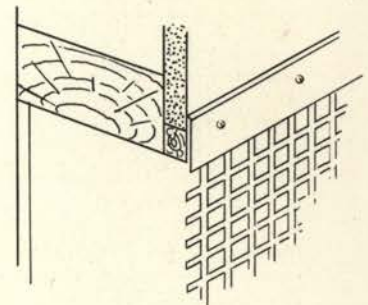
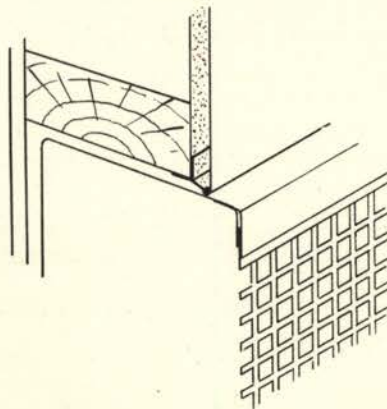

Above is shown a detail of the method of installing a Style H or HA Metal Front. Note that the front overlaps the finish plaster.

FINCAST

UNITED STATES RADIATOR CORPORATION

Detroit • Michigan

